

D758-ET MiniPurge[®]

Manual

ML434



Important Note:

It is essential for safety that the installer and user of the Expo system follow these instructions.

Please refer to the standard for principles and definition.

These instructions apply only to the pressurizing system. It is the responsibility of the manufacturer of the pressurized enclosure to provide instructions for the enclosure.

Expo Technologies reserves the right to replace any component, with one of the equivalent functionality.

Section 1: System Specification	1
MiniPurge® Control Unit Data	2
Relief Valve Unit and Purge Outlet Valve with integral spark arrestor.....	3
Section 2: Quick User Guide	4
Installation	4
Operation of the System	4
Section 3: Application Suitability	5
Section 4: Description and Principle of Operation	6
Section 5: Main Components	7
Air Supply Filter / Regulator	7
Logic Air Supply Regulator	7
Minimum Pressure Sensor	7
Purge Flow Sensor	7
Intermediate Sensor	7
Electronic Purge Timer	7
Purge Complete Valve.....	8
OR Gate	8
Alarm Only Circuit (/AO)	8
Visual Indicators	8
Power Interlock Switch	8
Alarm / Pressurized Switch.....	8
System Purging Switch (Optional).....	9
Intermediate Switch	9
Purge Valve	9
Purge Flow Restrictor	9
CLAPS Sensor	9
CLAPS Regulator	9
Relief Valve Unit.....	9
/PA Terminal Box.....	9
Section 6: Installation of the System	10
Relief Valve Unit	10
Air Supply Quality	10
Pipe Work	11
Multiple Enclosures	11
Provision and Installation of Alarm Devices	11
Power Supplies and their Isolation	11
Power Interlock Switch	11
Section 7: Commissioning	12
Commissioning the System	12
Normal Operation	13
Section 8: Maintenance of the System	14
General maintenance	14
Additional maintenance checks	14
Maintenance of Electronic Timer	14
Re-calibration of the Relief Valve Unit.....	15
Re-calibration of the Pressure Sensors.....	15
Section 9: Fault Finding	16
General Information	16
System purges correctly but trips and auto re-purges at the end of the purge time	16
Relief Valve opens (continuously or intermittently).....	17
System enters purging but purge indication does not occur.....	17
System begins purging but cycles fail to complete	17
Flow restrictor ball valve opens/closes by itself	17
Section 10: Recommended Spares List	18
Section 11: Glossary	18
Section 12: Drawings and Diagrams	18
Section 13: Certifications	19

Section 1: System Specification

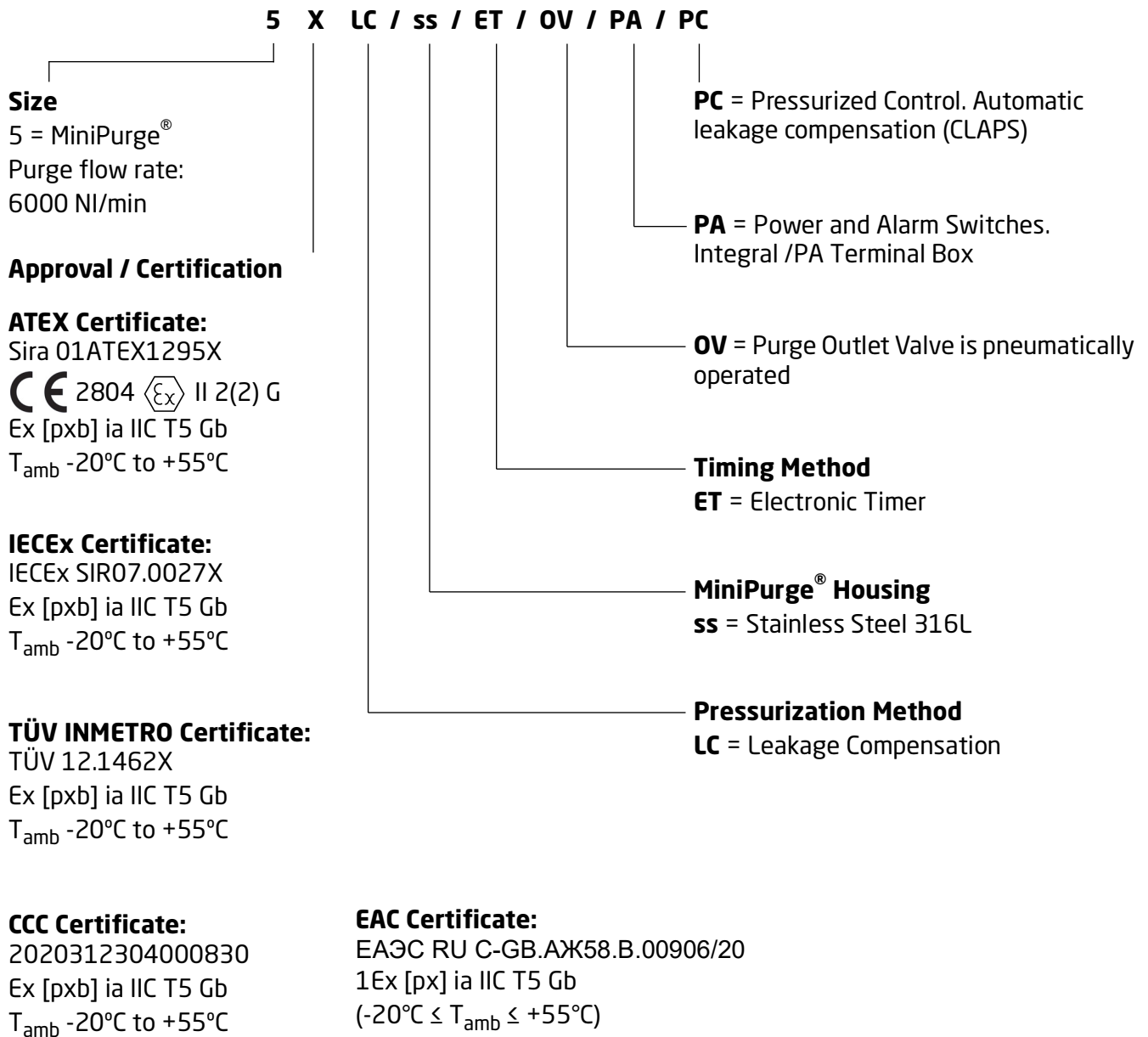

SPECIFIC CONDITIONS OF USE:

1. When using the AO, AS and DT options, the recommendations for the additional requirements of Ex p apparatus contained within IEC 60079-14 shall be applied.
2. The installer/user shall ensure that the MiniPurge Control Unit is installed in accordance with the equipment certificate that covers the combination of the pressurised enclosure(s) and MiniPurge Control Unit.
3. The values of the safety parameters shall be set in accordance with the equipment certificate that covers the combination of the pressurised enclosure(s) and MiniPurge Control Unit.
4. This MiniPurge Control Unit shall be incorporated into equipment and the appropriate Conformity Assessment Procedures applied to the combination. This certificate does not cover the combination.

5. The purge controller, low temperature version, shall be protected by a system that ensures that it cannot be energised if the temperature of the controller logic air or purge controller falls below -20°C. This system shall utilise the RTDs that are fitted to the purge controller to provide the appropriate level of system integrity.
 6. Where a Vortex cooler is fitted the hot air outlet pipe shall be kept free from obstructions and blockage.
 7. The following routine tests are to be carried out:
 - The vortex cooler is functioning correctly. (H6 and H7 options ONLY)
 - The pneumatic logic isolator is functioning correctly (H6 and H7 options ONLY)
 8. When using the 'LD' option, the LEDs have the following IS input parameters and it shall be supplied from a suitable intrinsically safe power supply for Zone 1 or Zone 2 depending on which zone the purge controller is being installed.
 $U_i = 30V$, $I_i = 100mA$, $P_i = 1W$, $C_i = 0$ and $L_i = 0$.
- Note: Some conditions apply only to specific models/options.

MiniPurge® Control Unit Data

Action on Pressure Failure:	Alarm and Trip (isolate power to pressurized enclosure), user adjustable Alarm Only.
Type of Operation:	Automatic leakage compensation using the Closed Loop Automatic Pressurization System (CLAPS System).
Leakage Compensation Capacity	1500 NI/min max.
Enclosure Material:	Stainless Steel 316L.
Mounting Method:	Wall mounting straps. Fixing holes as per drawing.
Temperature Limits:	-20°C to +55°C
Compressed Air Supply:	Clean, dry, oil free air or inert gas. Refer to Air Supply Quality section in Installation of the System.
Supply Pressure:	5 to 16 barg (73 to 232 psi).
Main Regulator:	Set at 5 barg, 40 µm automatic drain supply inlet filter.
Logic Regulator and Gauge:	Fitted and set to 2.5 barg (36 psi).
Process Connections:	Purge supply and outlet to pressurized enclosure 1" NPT female. Minimum supply line 25 mm (1") ID tube, inlet sized appropriately for flow rate. Reference points & signals 1/8" NPT female, minimum 6 mm pipe to be used.
Visual Indicators:	Alarm (Red ●) / Pressurized (Green ●). System Purging: 4 LEDs that flash sequentially to indicate elapsed time (black when not purging).
/PA Terminal Box:	Stainless Steel, Ex e IIC T5 Gb / Ex tb IIIC T100°C Db IP66 Tamb : -20°C to +55°C with terminals, front access cover & lower removable gland plate. Stainless Steel, Ex e IIC T4 Gb Tamb : -20°C to +60°C with terminals, front access cover & lower removable gland plate. For user instruction manual refer to ML358, attached to the manual.
Power Interlock Switch:	DPNO switch, contact ratings 250 Vac 4 Amps (AC-15) / 24V DC 4A, Ex d IIC T6 Gb / Ex tb IIIC T80°C Db.
Alarm Switch:	SPCO switch, contact ratings 250 Vac 4 Amps (AC-15) / 24V DC 4A, Ex d IIC T6 Gb / Ex tb IIIC T80°C Db.

Intermediate Switch:	SPCO switch, contact ratings 250 Vac 4 Amps (AC-15) / 24V DC 4A, Ex d IIC T6 Gb / Ex tb IIIC T80°C Db.
System Purging Switch (Optional):	SPCO switch, contact ratings 250 Vac 4 Amps (AC-15) / 24V DC 4A, Ex d IIC T6 Gb / Ex tb IIIC T80°C Db.
Minimum Pressure Sensor:	Minimum: 0.5 mbarg. Maximum: 5.0 mbarg. Default Setting: 1.5 mbarg. Tolerance -0, +0.7 mbarg.
Intermediate Sensor:	Minimum: 2.0 mbarg. Maximum: 10 mbarg. Default Setting: 5.0 mbarg. Tolerance: -0, +10%.

Note: There must be a 1.5 mbarg difference between the minimum pressure and intermediate sensors.

Purge Flow Sensor:	Set at 6.4 mbarg (Tolerance: -0, +10%).
CLAPS Sensor:	Minimum: 5.0 mbarg. Maximum: 15 mbarg. Default Setting: 10 mbarg. Tolerance: -0, +10%

Note: there must be a 2.5 mbarg difference between the intermediate and CLAPS sensor calibration point. For example: Minimum pressure = 5 mbarg, intermediate pressure = 6.5 mbarg, CLAPS sensor = 9 mbarg.

Purge Time:	User selectable, in 1 minute intervals, up to 99 minutes (tolerance -0, +3 seconds). Default Setting 99 minutes.
Weight:	27 kg (60lb).

Relief Valve Unit and Purge Outlet Valve with integral spark arrestor

Type:	RLV104/ss/FS, Design number D758RLV.		
Bore:	Purge Outlet Valve Ø 104 mm, Relief Valve Ø 75 mm.		
Relief Valve Lift-Off Pressure:	Minimum:	20 mbarg.	
	Maximum:	50 mbarg.	
	Default:	30 mbarg (+0, -20%).	
Flow Rate:	Range:	2000, 3000, 4000, 5000, or 6000 NI/min.	
	Default:	2000 NI/min.	
Material:	Housing:	Stainless steel 316L.	
	Gasket:	Silicone foam.	
	Spark arrestor:	Stainless steel mesh.	
Mounting Method:	Rectangular cut-out and fixing holes as per drawing.		
Weight:	7 kg (15.4 lb).		

Note: Special settings available on request, refer to Test and Inspection Sheet.

Section 2: Quick User Guide

Installation

The MiniPurge system must be installed by a competent engineer, in accordance with relevant standards, such as IEC / EN 60079-14 and any local codes or practice.

- Mount the purge system in accordance with the hook-up drawing.
- Ensure the system is installed according to the full instructions in the “Installation of the System” section of this manual.
- All piping must be clean and free of dirt, condensation and debris prior to connection to the purge system or pressurized enclosure.
- It is strongly recommended that a local isolation valve is installed on the air supply upstream of the purge system.

Note: Most faults are due to restricted air supply, inadequate supply pipe work or drop in air supply pressure during the purge process.

Operation of the System

Once the system is installed correctly, turn on the air supply. Refer to Commissioning section.

Indicator	Colour	Status
Alarm / Pressurized	Red ●	Low pressure alarm (enclosure pressure too low)
Purging	Black ●	Purge flow too low or not in purge mode

The purge system commences the purge cycle:

- The purge air will enter the enclosure.
- The pressurized enclosure will obtain a positive pressure.
- The Purge Outlet Valve will open within the Relief Valve Unit.
- The air will then exit the Relief Valve Unit housing via the spark arrestor.

Indicator	Colour	Status
Alarm / Pressurized	Green ●	Pressurized (minimum enclosure pressure achieved)
Purging	Black ●	Purge flow too low

Open the Purge Flow Restrictor Valve until the air flow reaches the required rate; the system will initiate the timed purge cycle. Start a stopwatch when the purging indicator flashes yellow.

Indicator	Colour	Status
Alarm / Pressurized	Green ●	Pressurized
Purging	Sequential flashing Yellow ●	Purge flow rate above minimum

On completion of an uninterrupted purge cycle of the required length, the system will indicate purge complete. Stop the stopwatch when the purging indicator stops flashing.

Indicator	Colour	Status
Alarm / Pressurized	Green ●	Pressurized and in leakage compensation mode
Purging	Black ●	No longer in purge mode

Check stopwatch timing to verify that the actual purge time is equal to or greater than the required purge time.

Note: The recorded purge time must never be less than the required purge time.

The system is now operating correctly in leakage compensation mode.

If the system has not performed as expected, check the installation thoroughly and ensure it has been carried out according to the instructions.

If an obvious problem has not been highlighted and corrected, follow the procedures in the Fault Finding section.

If all checks have been carried out and the system still does not perform as expected, contact your local distributor or Expo Technologies.

Section 3: Application Suitability

MiniPurge systems are certified for use in hazardous locations, where the hazardous location is non-mining (above ground) and the hazard is caused by flammable gasses, vapours or dust. Depending on the model the systems may be used in IECEx and ATEX Zone 1 and/or Zone 2 - Categories 2 and 3 respectively.

MiniPurge systems may be used for hazards of any gas group. Apparatus associated with the MiniPurge system, such as intrinsically safe signalling circuits and flameproof enclosures containing switching devices may be limited in their gas group. The certification documentation supplied with any such devices must be checked to ensure their suitability.

This system is primarily designed for use with compressed air. Where other inert compressed gasses are used (Nitrogen, for example) the user must take suitable precautions so that the build up of the inert gas does not present a hazard to health. Consult the Control of Substances Hazardous to Health (COSHH) data sheet for the gas used. Where a risk of asphyxiation exists, a warning label must be fitted to the pressurized enclosure.

The following materials are used in the construction of MiniPurge systems. If substances that will adversely affect any of these materials are present in the surrounding environment, please consult Expo Technologies for further guidance.

Materials of Construction			
Stainless Steel	ABS	Polyurethane	Silicone
Mild (Carbon) Steel	Aluminium	Polycarbonate	Neoprene
Brass	Nylon	Acrylic	Polyester (glass filled)

Section 4: Description and Principle of Operation

The MiniPurge[®] system is pneumatic in operation, with electrical interfaces.

Purge and pressurization is a method of protection used in Zone 1 (21) and/or Zone 2 (22) hazardous locations to ensure that the interior of an enclosure is free of flammable gas. Addition of a MiniPurge[®] system allows the electrical equipment within the enclosure to be used safely in a hazardous location.

The principle of purge and pressurization is as follows:

- Clean compressed air or inert gas is drawn from a non-hazardous location.
- The interior of the pressurized enclosure is flushed to remove any hazardous gas or dust.
- This is introduced into the pressurized enclosure to keep the internal pressure at least 0.5 mbarg above the external pressure.
- Whilst pressurized, flammable gas cannot enter the enclosure from the environment.

Prior to switching on the power to the electrical equipment, the enclosure must be purged to remove any flammable gas that might have entered the enclosure before pressurization. Purging is the process of removal contaminated air and replacement with air (or inert gas) known to be free from flammable gas. The duration of this purge process is normally ascertained by performing a purge test.

At the end of the purge cycle the system automatically switches to leakage compensation mode. The Purge Outlet Valve is closed and the airflow is reduced but remains high enough to compensate for the leakage of air from the enclosure whilst maintaining the minimum over pressure state.

In the event of pressure failure within the pressurized enclosure the system will raise an alarm in the form of visual indicators and a volt free contact depending on the specification of the system. The default action on loss of pressurization is alarm and automatic disconnect of power (A&T - Alarm and Trip). This can be changed by the customer to Alarm Only (/AO), please refer to section titled Main Components.

The MiniPurge system incorporates a Closed Loop Automatic Pressurization System (CLAPS). This allows the system to detect a rise or fall of the enclosure's internal pressure and adjust the leakage compensation rate accordingly. Pressure variations are more likely during sudden start up of large rotating electrical machines but can also be caused by changes in running temperature. This system has been specifically designed to maintain a stable internal pressure within the enclosure.

Pressure characteristics during purge and pressurization of a pressurized enclosure using a MiniPurge system that incorporates a CLAPS system:

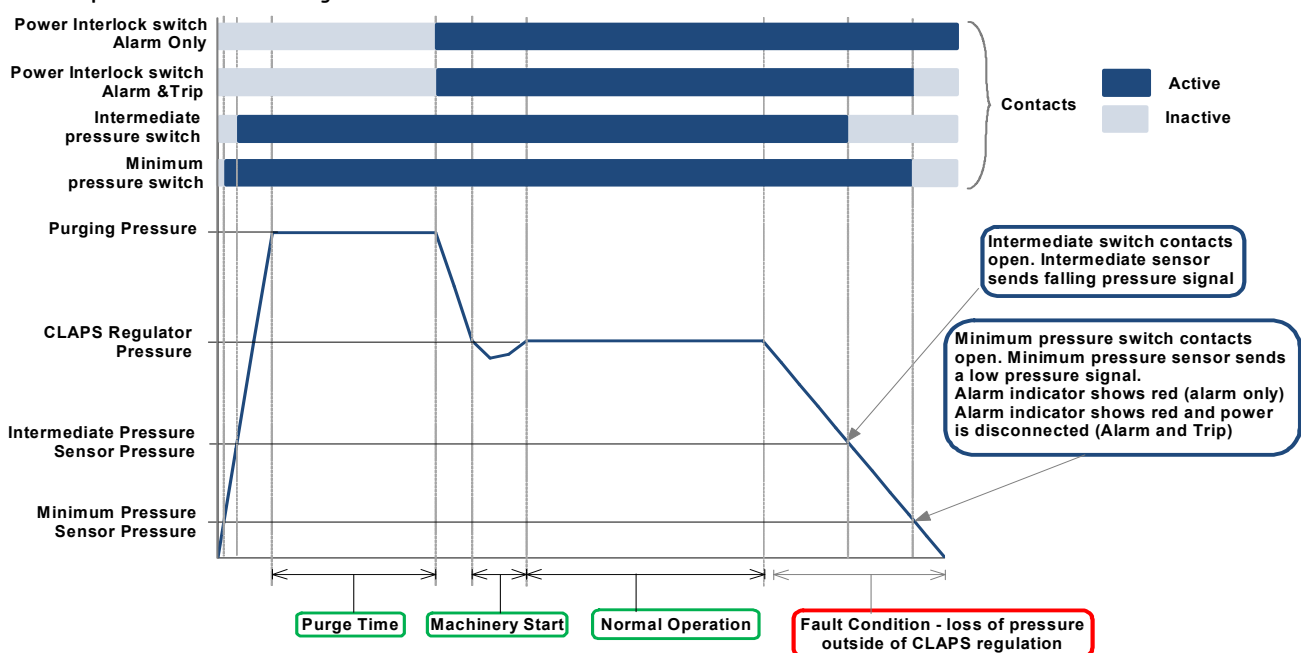

Section 5: Main Components

Air Supply Filter / Regulator

The unit is provided with a 40 µm liquid / dust filter element as a precaution. The user of the MiniPurge[®] system must ensure that air supply is to the quality stated in Air Supply Quality paragraph found in the Installation of the System section. The regulator is factory set to 5 barg (73 psig) and regulates the pressure of an air supply between 5 and 16 barg (73 to 232 psig). A pressure gauge is fitted down stream of the filter; this should indicate no less than 5 barg (73 psig). During the purge cycle a pressure drop will be indicated on the gauge.

Logic Air Supply Regulator

This device provides the system with a stable air supply pressure to the logic system and allows consistent operation. The pressure level is factory set to 2.5 barg (36 psig) and can be verified by means of the integral pressure gauge.

Minimum Pressure Sensor

This monitors the pressure inside the pressurized enclosure. When the pressure is below the minimum required for safe operation, the pressure sensor causes the system to reset and the Alarm / Pressurized indicator turns **Red** . The sensor is factory calibrated and set to operate in falling pressure at or above the minimum specified pressure.

Purge Flow Sensor

The Purge Flow Sensor monitors flow through the Purge Outlet Valve. At correct purge flow rates, above the minimum specified for purging, the sensor sends a signal that activates the purge timer. This sensor is factory calibrated to operate on falling flow rate at or above the minimum specified purge flow rate.

Intermediate Sensor

This sensor monitors the pressure inside the pressurized enclosure. It senses when the pressure drops and provides early warning before the low pressure sensor trips the system.

Electronic Purge Timer

When both the enclosure pressure and the purge flow rate are correct, the Purge Flow Sensor activates the timer and the electronic timer starts. The timing period is selected using switches mounted on the timer module.

Note: Setting the timer to 00 minutes will cause infinite purging; the cycle will never complete.

During timing, the percentage of the purge cycle is indicated by four LEDs which flashes sequentially while the timer is running.

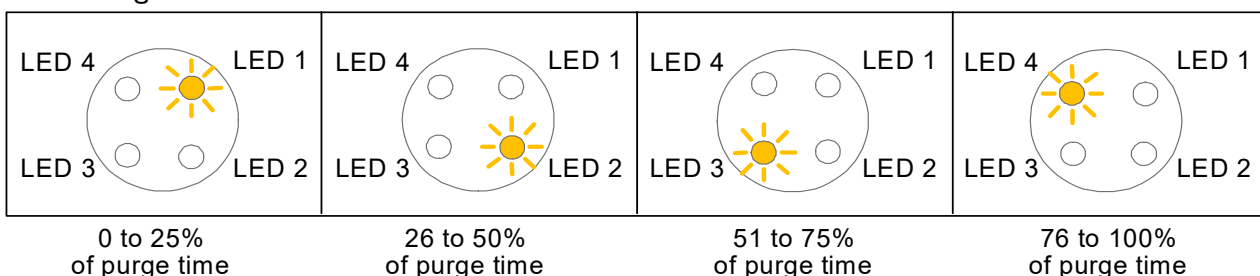

The Electronic Timer contains an intrinsically safe battery pack that needs regular replacement. See Commissioning section.

Purge Complete Valve

This valve receives a signal from the purge timer that indicates the completion of the purge cycle and verifies that the pressurization signal is still present. If both conditions are satisfied a signal is sent to indicate that the purge is complete. This performs two functions: to turn on the electrical supply to the pressurized enclosure and to reduce the high purge flow rate to leakage compensation mode. It also provides a hold-on signal that maintains the leakage compensation mode with the power switch on, even when the purge timer has reset ready for the next purge cycle.

OR Gate

This device provides the Purge Complete Valve with the hold-on function referred to previously. When either the timed-out signal or the purge complete signal is present it allows the pilot signal to be sent to the purge complete valve.

Alarm Only Circuit (/AO)



If the pressure in the pressurized enclosure is too low the system will normally cut off electrical power to it. In certain circumstances, where local codes of practice allow, the system can be altered to provide a hold-on circuit that will maintain the electrical power supply to the pressurized enclosure while also providing a pressure failure alarm. The user must respond to the alarm and either restore the pressure to the pressurized enclosure or otherwise make the installation safe; for example, cut off the electrical supply. The decision to use the Alarm Only facility, and the allowable length of time for non-pressurized operation, is the responsibility of the user.

Warning: It is potentially dangerous to energise the pressurized enclosure in a non-pressurized condition when it is known that there is potentially explosive gas or dust in the hazardous location.



Visual Indicators



Visual indicators are fitted to provide status information to the operator.

Alarm / Pressurized Indicator

Green* 	Pressurized
Red 	Pressure Alarm (enclosure pressure low)

System Purging Indicator

Black* 	Purge flow too low (not in purge mode)
Yellow (flashing) 	Purging (flow above minimum)

* The Green  / Black  combination indicates normal operation of the pressurized enclosure after the initial purging cycle has been completed.

Power Interlock Switch

This flameproof power switch is activated by the signal from the Purge Complete Valve. This activation can be used to turn on the electrical supply to the pressurized enclosure. The cable from the switch is terminated in the /PA terminal box.

Alarm / Pressurized Switch

This flameproof switch is operated by the pressurized signal. It allows a remote electrical system status indicator to show either pressurized or a pressure failure alarm. The cable from the switch is terminated in the /PA terminal box.

System Purging Switch (Optional)

This switch is operated by the purge flow signal that allows a remote electrical system status indicator to signal that the system is purging; sometimes referred to as “purge-in-progress”. The cable from the switch is terminated in the /PA terminal box.

Intermediate Switch

This is a flameproof switch which is activated by the signal from the Intermediate Sensor. The cable from the switch is terminated in the /PA terminal box.

Purge Valve

This changeover valve selects between purge air flow or leakage compensation. It is sized to allow sufficient air into the enclosure during purging based on: the specified air supply pressure range, the minimum specified purging outlet flow rate +10% and the expected leakage rate from the pressurized enclosure. At the end of the purge cycle, the purge valve closes in response to the “Purge Complete” signal; it remains in the closed position until the next purge cycle is initiated.

Purge Flow Restrictor

This valve restricts the purge flow to the minimum required flow rate. The Purge Flow Restrictor must be readjusted during commissioning.

CLAPS Sensor

This sensor monitors the pressure within the pressurized enclosure and sends a control signal to the CLAPS Regulator. The normal running pressure must be determined prior to system start-up so that the CLAPS Sensor may be set to the level required to control the CLAPS Regulator.

CLAPS Regulator

This is the regulator that controls the leakage compensation air flow into the enclosure after the purging is complete. It either increases or decreases the air flow into the enclosure as appropriate to maintain a stable running pressure. The CLAPS Regulator must be set at the time of commissioning.

Relief Valve Unit

The Relief Valve Unit allows the purge air to exit the enclosure safely via a built-in spark arrestor. This spark arrestor is designed to prevent the emission of arcs, sparks and incandescent particles produced within the pressurized enclosure.

Purge air passes through the Relief Valve Unit; the preset pressure differential across the appropriate orifice ensures that the purge flow sensor is activated once the selected purge flow has been attained.

During the purge cycle a pneumatic cylinder operates the Purge Outlet Valve that lets the air from inside the enclosure exhaust through the Relief Valve Unit. When the system changes to leakage compensation mode, the Purge Outlet Valve is closed and the enclosure sealed.

The Relief Valve Unit has an in-built relief valve. This is sized to ensure that, if the air supply pressure rises up from the specified maximum, the internal enclosure pressure will not exceed the specified maximum working pressure of the pressurized enclosure.

/PA Terminal Box

The Terminal Box is increased safety (Ex e) certified and incorporates the terminal connection points for the alarm and interlock switches. All contacts provided are volt free (dry).

Cable entry methods (for example conduit or cable glands) must also be certified to IECEx, ATEX and/or INMETRO standards (and must match the certification scheme for the motor). The main requirement is that IP66 (or better) ingress protection must be provided by use of seals or washers.

Section 6: Installation of the System

The MiniPurge is designed for use under normal industrial conditions of ambient temperature, humidity and vibration. Please consult Expo before installing this equipment in conditions that may cause stresses beyond normal industrial conditions. The MiniPurge system must be installed by a competent person in accordance with relevant standards, such as IEC / EN 60079-14, and any local codes of practice.

The MiniPurge control unit should be installed either directly on, or close to the pressurized enclosure. It should be installed such that the system indicators and certification labels are in view.

All parts of the system carry a common serial number. If installing more than one system, ensure that this commonality is maintained within each system installed.

Relief Valve Unit

To achieve effective purging, the points where air enters and exits the pressurized enclosure should normally be at opposite ends of the enclosure. The RLV unit must be mounted vertically and there should be a minimum clearance of 300 mm (12") around the spark arrestor (purge outlet).

It is important that the interior and exterior of the spark arrestor is kept clean and debris is not allowed to accumulate; this might affect the calibration of the device. In particular, the exterior of the spark arrestor should not be painted or blocked in any way.

Air Supply Quality

The MiniPurge system should be connected to a protective gas supply, which is suitable for purging and pressurization.

The supply pipe connection to the MiniPurge must be appropriate for the maximum input flow rate for the application.

The air supply must be regulated at a pressure less than the maximum stated inlet pressure.

The air supply must be: clean, non-flammable and from a non-hazardous location. The air should be of Instrument Air Quality. Although the purge control system will operate with lower air quality, its operational life will be adversely affected. The equipment that is being protected by the MiniPurge may also suffer because of poor air quality.

With reference to BS ISO 8573-1: 2010, Instrument Air is typically specified as:

Particle Class 1

In each cubic metre of compressed air, the particulate count should not exceed 20,000 particles in the 0.1 to 0.5 micron size range, 400 particles in the 0.5 to 1 micron size range and 10 particles in the 1 to 5 micron size range.

Humidity or pressure dew point

The dew point, at line pressure, shall be at least 10 °C below the minimum local recorded ambient temperature at the plant site. In no case, should the dew point at line pressure exceed +3 °C.

Oil Class 2

In each cubic metre of compressed air, not more than 0.1mg of oil is allowed. This is a total level for liquid oil, oil aerosol and oil vapour.

When an inert gas is being used to supply the purge system, risk of asphyxiation exists. Refer to Application Suitability section.

Before connection of the air supply to the purge system, the supply pipe work should be flushed through with instrument quality air to remove any debris that may remain in the pipes. This must be carried out for at least 10 seconds for every meter of supply pipe.

Unless a supply shut-off valve has been fitted to the MiniPurge system, an external shut-off valve with the same, or larger, thread size as the Control Unit inlet fitting should be fitted by the installer to prevent any restriction of purge flow.

The purge air from the MiniPurge Control Unit should be piped within the pressurized enclosure to ensure purging of potential dead air spots.

The purge system is fitted with an internal regulator factory set to 3 bar feeding the logic.

Pipe Work

If the MiniPurge is not connected directly to the pressurized enclosure, pipe work and fittings used to connect the Control Unit to the pressurized enclosure should be either metallic or appropriate to the environment into which the system is installed. No valve may be fitted in any signal pipe connecting the Control Unit to the pressurized enclosure. This pipe work must be fitted in accordance with local codes of practice where relevant.

Multiple Enclosures

This system is suitable for the purge and pressurization of the primary pressurized enclosure and its associated terminal boxes.

Provision and Installation of Alarm Devices

When the pressure inside the pressurized enclosure is above the minimum, the Minimum Pressure Sensor returns a positive (**pressurized**) signal causing the alarm indicator on the control unit to change from **red** to **green**.

When the pressure falls below the minimum permissible the positive (**pressurized**) signal is removed. This absence of signal indicates a **low pressure alarm** condition and causes the alarm indicator on the control unit to go from **green** to **red**.

There are volt free (dry) contacts available within the terminal box for remote usage.

The user must make use of this alarm facility in accordance with the local code of practice for Action on Pressure or Flow Failure. Most codes include the following recommendations:

- **Zone 1 Installations:** Alarm and Automatic Trip of Power.
- **Zone 2 Installations:** Alarm Only on pressure or flow failure with power being removed manually.

Power Supplies and their Isolation

All power entering the pressurized enclosure should have a means of isolation. This requirement also applies to any external power sources that are connected to the equipment such as volt-free (dry) contacts within the pressurized enclosure. This is commonly achieved using the Power Interlock Switch.

Power Interlock Switch

This switch is a Double Pole Normally This switch is a Double Pole Normally Open, double-break switch: it provides two independent contacts that should be connected in series and used to isolate the power. This can be achieved using suitable certified intrinsically safe barriers. These contacts are terminated and accessible to the user in the terminal box.

It is the responsibility of the user to ensure that the switch is only operated within appropriate technical limits.

The switch must be replaced after any short circuit that occurs within the main circuit; the switch is a piece of encapsulated equipment and as such it is not possible to check the state of the contacts. Technical modifications to the switch are not permitted.

Prior to commissioning, check that the terminal box is clean, the connections have been made properly, the cables laid correctly and all screws in the terminals are secure.

In all cases the application and isolation of power must be controlled by the MiniPurge system using the power interlock signal.

No switches are permitted between the power switch and the MiniPurge system other than an authorized manual override circuit.

The safe use of this switch is the responsibility of the user, all electrical installations must conform to local codes of practice.

Exception

Power to apparatus that is already suitable for use in hazardous locations need not be isolated by the MiniPurge system.

Section 7: Commissioning

Commissioning the System

Note: The steps 11 and 15 to 21 represent detailed commissioning tests

The following equipment is needed for this process:

- Continuity meter
- Gauge manometer (0 to 200 mbarg)
- Differential manometer

If, after commissioning, the system does not perform as expected, refer to the Fault Finding Section.

Follow the steps as outlined:

1. Check all connections and that the Relief Valve Unit is fitted correctly with an unobstructed path to the purge exhaust.
2. Close the Purge Flow Restrictor Valve.
3. Fully open external supply shut-off valve where fitted.
4. Check that the internal logic pressure gauge reads 2.5 barg / 36 psi / 250 kPag.
5. Check that the pressure gauge on main air supply reads 5 barg / 73 psi / 500 kPag.
6. Check that the Pressure Relief Valve is correctly set by disconnecting the minimum pressure sensing pipe at the bulkhead fitting on the input to the MiniPurge[®]. This will disable all of the pressure sensors.
 - Using a 4 mm nylon tube, connect a manometer to the bulkhead fitting from which the minimum pressure sensing pipe was removed.
 - Open the Purge Flow Restrictor Valve very slowly, until the Pressure Relief Valve opens
 - Check the opening pressure is within calibration limits.
 - This test can be carried out several times to ensure repeatability and compliance. Refer to the Maintenance of the System section if the Relief Valve needs recalibrating.
7. Close the Purge Flow Restrictor Valve.
8. Remove the manometer and reconnect the minimum pressure sensing pipe to the bulkhead fitting.
9. Remove red plug from the top of the Minimum Pressure Sensor and connect a gauge manometer.
10. Connect a differential manometer to the test points on the flow sensor.

11. To check sensor calibration

- The internal pressure in the pressurized enclosure must be below Relief Valve lift off pressure and above the CLAPS pressure
- At this time the pressurized indicator should be **green**.
- gradually open Purge Flow Restrictor Valve until purging indicator **flashes yellow**.

Note: For large volumes it may take a long time for the purge flow to start.

- very slowly close Purge Flow Restrictor Valve until the purging indicator stops **flashing yellow**.
- Take a reading from pressure gauge.

12. To set the purge flow rate:

- Turn on the compressed air to the MiniPurge®.
- Gradually open the Purge Flow Restrictor Valve until the **black / yellow** indicator changes to **yellow (flashing)**.
- The flashing yellow indicator confirms the correct flow rate.
- The differential pressure should be greater than 6.4 mbarg.
- The relief valve is supplied with different orifice plates for the specified flow rate. This orifice plate is held in position by two M3 screws and can easily be changed by removing the large cover plate from over the outlet valve assembly and screws.

Warning: When opening the Purge Flow Restrictor Valve, ensure the over pressure within the pressurized enclosure does not exceed the pressure relief valve setting.

13. The purge timer will start as soon as the Purging Indicator **flashes yellow**. Check that the time delay between the indicator turning to **yellow (flashing)** and returning to **black** is not less than the minimum time required for complete purging of the pressurized enclosure. Times in excess of minimum are permitted.
14. After the purge has been completed, the Purge Valve will close and the air flow into the pressurized enclosure will be controlled by the CLAPS Regulator. The initial setting may be too high or too low.
15. Gradually turn the CLAPS Regulator anti-clockwise to reduce enclosure pressure.
16. Reduce regulator until intermediate sensor causes contacts to open.
17. Check the manometer on the minimum pressure sensor.
18. Continue to reduce the CLAPS Regulator to test the minimum pressure sensor.
19. To check operation of Minimum Pressure Sensor, check readings on manometer as system will automatically re-purge when it reaches minimum pressure.
20. While the system re-purges, return the CLAPS Regulator to the initial setting.
21. If minimum pressure is below the set point, refer to the Recalibration section
22. If the setting is too high, continual rising and falling of the enclosure pressure will be seen as the CLAPS Regulator automatically shuts off and reinstates the flow. The CLAPS Regulator should be adjusted to reduce the flow into the pressurized enclosure by turning the adjuster screw anti-clockwise.
23. If the initial setting is too low the CLAPS Regulator may not provide enough air flow causing a gradual decline in enclosure pressure. To increase the flow into the pressurized enclosure, adjust the CLAPS Regulator Relief Valve unit by turning the adjuster screw clockwise.
24. To test the CLAPS settings, create a leak in the system by removing a bolt or loosening a gland plate in order to create a 15mm hole. Remember to replace bolt or retighten gland plate after testing.
25. The setting of the CLAPS Sensor is factory calibrated to the normal working pressure expected in the pressurized enclosure, typically 10 mbarg. The pressure in the pressurized enclosure should be stabilized as close as possible to this figure. This can be checked by a manometer attached to the minimum pressure sensor.
26. Tighten locknut on flow restrictor to 2.5 N/m².
27. Remove the air supply to the system, remove all test equipment and replace all plugs.

Normal Operation

For normal operation of the system, after commissioning has been carried out it is possible to turn the air supply valve on or off to start or stop the system. After this, the purge and pressurization sequence is automatic.

Section 8: Maintenance of the System

General maintenance

The maintenance of the system outlined in this manual should be supplemented with any additional requirements set out in appropriate local codes of practice.

The following checks should be carried out every 6 - 36 months dependent on environment according to IEC / EN 60079-17

- Tests outlined in the Detailed Commissioning section.
- Ensure that the Relief Valve Unit is free from contamination prior to making any adjustment. To do this:
 - Remove large cover plate using a 8 mm spanner (wrench).
 - Check that the interior and all components are clean and free from contamination.
 - Replace large cover plate.
- Check the condition of the air supply filter element. Clean or replace as necessary.

Additional maintenance checks

The following additional checks are recommended at least every 3 years:

- Apparatus is suitable for use in the hazardous location.
- There are no unauthorised modifications.
- The air supply is uncontaminated.
- The interlocks and alarms function correctly.
- Approval labels are legible and undamaged.
- Adequate spares are carried.
- The action on pressure failure is correct.

Maintenance of Electronic Timer

This should be carried out every 3 years.

- The battery may be hot-swapped in the hazardous location without affecting the operation of the Mini-Purge System. The Battery **MUST NOT** be replaced during a purge cycle.
- After replacing the battery, the commissioning tests should be repeated.
- The battery module should be disposed of in accordance with the battery's Material Safety Data Sheet and any relevant local and national directives.

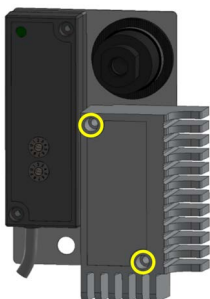

Use a flat head screwdriver to loosen and remove the two retaining screws from the battery pack.

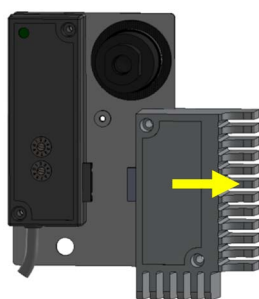

Pull the battery module away from the e-timer to unplug the battery from the e-timer.

WARNING! Pulling at an angle could break the E-timer connector.



Insert the screws and washers into the new battery module.

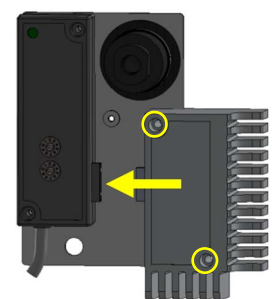

Fully plug the new battery module into the e-timer.

Re-calibration of the Relief Valve Unit

Warning! Incorrect adjustment of the Relief Valve Unit can lead to significant over pressure and result in damage to the enclosure.

If maximum pressure setting is reached, stop adjustment, and reduce the pressure.

To perform the following adjustments, an 8 mm spanner (wrench) and a 2.5 mm hex key will be required. Ensure that the Relief Valve Unit is free from contamination prior to making any adjustment. To do this:

- Remove large cover plate using an 8 mm spanner (wrench).
- Check that the interior and all components are clean and free from contamination.
- Replace large cover plate

To adjust the lift off pressure of the Relief Valve:

- Attach test equipment as described in the Commissioning Section.
- Remove small cover plate.
- Whilst holding the central adjustment screw in position using the hex key, loosen the retaining nut.
- Adjust the hex key clockwise to increase, or anti-clockwise to reduce the lift off pressure.
- Before testing, retighten the locking nut whilst holding the adjustment screw in place.
- Carry out the commissioning tests to check the correct setting of the relief valve after adjustment.
- The adjustment is sensitive, and it is recommended that a $\frac{1}{4}$ turn (maximum) adjustments are applied between tests.

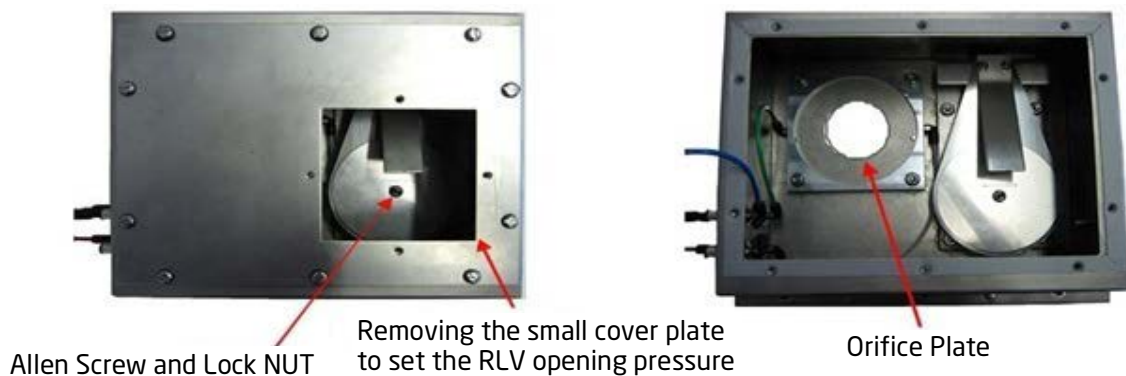

Re-calibration of the Pressure Sensors

The brass nozzle on the sensor is sealed into position using Loctite thread sealant. If the thread has seized up, remove to a safe area and heat slightly to soften prior to making any adjustment. This prevents potential damage to the brass of the nozzle.

- Disconnect pipe work from the sensor, including pipe located below the sensor.
- Remove sensor by unscrewing anti-clockwise.
- The nozzle is located under the sensor.
- The adjustment is sensitive, turn the nozzle in $\frac{1}{8}$ of a turn step.
- Turn clockwise to reduce the pressure setting and anti-clockwise to increase.
- Replace sensor, screwing clockwise, then reconnect all pipe work.

Fault Finding

General Information

If you are having problems that cannot be corrected using one of the methods described, please call Expo or your supplier for further assistance. If the system is less than 12 months old, parts under warranty should be returned to Expo for investigation. A full report of the fault and the system serial number should accompany

the parts.

It is common for problems with the MiniPurge system to be caused by contamination of the air supply with oil, water, or dirt. To prevent these problems, the air supply must contain a dust filter and a water filter. This will ensure that the air is instrument quality and protect both the purge system and the equipment being purged. This filtration system is not provided by Expo and must be sourced separately.

Contamination can enter the system from a number of sources. To prevent this, it is essential that the procedures described in the Installation section are carried out prior to first use of the system. These procedures should also be carried out following any disconnection and re-connection of the pipe work. Failure to perform these procedures may cause damage to the system that will not be covered by the warranty.

The system has been designed for ease of fault finding and many of the components fitted are plug-in or chassis mounted. Check components by substitution only after establishing that such action is necessary.

Before carrying out the fault finding procedures, ensure that:

- Both the main air pressure to the system and for Motor Purge Systems, the regulated pressure to the logic manifold are as specified on the settings sheet.
- Air pressure does not drop below the minimum supply pressure during purging; most faults reported are due to insufficient air supply during the purge cycle.

System purges correctly but trips and auto re-purges at the end of the purge time

This is a result of the pressure within the pressurized enclosure being below the minimum pressure sensor setting. The pressure can be checked using a manometer. The most common causes of this problem are outlined below.

Fault Location	Cause	Solution
Pressurized Enclosure	The actual Motor Housing pressure below the setting of the Minimum Pressure Sensor.	<ul style="list-style-type: none"> • Check it with a manometer.
	Enclosure leaking excessively.	<ul style="list-style-type: none"> • Ensure all doors and covers are closed and that all conduit and cable glands are properly sealed. • Seal any other leaks.
	Pressure sensing tube damaged.	<ul style="list-style-type: none"> • Replace tubing.
Leakage Compensation Valve	The Leakage Compensation Valve setting is too low and the Motor Housing is tripping out after purging due to low pressure.	<ul style="list-style-type: none"> • Try increasing the setting of the Leakage Compensation Valve to raise the pressure in the Motor Housing at the end of purging.
MiniPurge [®] Control Unit	The Minimum Pressure Sensor setting has drifted above the setting	<p>The Minimum Pressure Sensor needs re-calibrating.</p> <ul style="list-style-type: none"> • Refer to Re-calibration of Pressure Sensors in the Maintenance section

Relief Valve opens (continuously or intermittently)

Fault Location	Cause	Solution
Pressurized Enclosure	Enclosure pressure is too high.	<ul style="list-style-type: none"> Adjust the Leakage Compensation Valve.
Relief Valve Unit	Relief Valve malfunction.	<ul style="list-style-type: none"> Consult manufacturer's manual.

System enters purging but purge indication does not occur

Fault Location	Cause	Solution
Air Supply	Insufficient flow rate due to inadequate air supply pressure. Often due to pressure drop in the supply pipe.	Static pressure of 5 barg must be maintained during purge <ul style="list-style-type: none"> Check air supply pressure at the inlet to the control unit. Ensure that the supply pipe bore is suitable for the flow rate
Pressurized Enclosure	Excessive leakage from the pressurized enclosure.	<ul style="list-style-type: none"> Check around the enclosure while purging is taking place. Total leakage at purge outlet valve should not exceed 10% of purge flow sensor setting. Check for leakage down cables and conduit.
Pipe Work	Tubing from Relief Valve flow sensing point not airtight.	<ul style="list-style-type: none"> Ensure fitting nuts are tightened. Check for tube damage. Repair as necessary.
MiniPurge Control Unit	Flow sensor setting incorrect.	<ul style="list-style-type: none"> Check the pressure is correct on the flow sensor.

System begins purging but cycles fail to complete

Fault Location	Cause	Solution
Electronic Timer	Time set to 00	<ul style="list-style-type: none"> Reset timer to correct purge time.
	The intrinsically safe battery pack is discharged	<ul style="list-style-type: none"> Replace as necessary.

Flow restrictor ball valve opens/closes by itself

Fault Location	Cause	Solution
Flow restrictor	Flow restrictor locknut loose	<ul style="list-style-type: none"> Tighten locknut to 2.5 N/m²
	Flow restrictor Shakeproof washer missing/damaged	<ul style="list-style-type: none"> Replace washer - Expo part code S0019/028

Section 9: Recommended Spares List

Part Number	Description
KFL-A01N-001	Filter Kit for S0015/275 filter / regulator
S0030/606	Purge flow sensor factory set to 6.4 mbarg
S0030/016	Minimum Pressure sensor, must be factory set to the value as stated on the Customer Test and Inspection Sheet
HSI-0160-000	Intermediate pressure sensor
S0030/588	CLAPS Sensor must be factory set to the value as stated on the Customer Test and Inspection Sheet
S0015/018	Pressure gauge (Air Supply Pressure), 0 - 10 barg
S0015/135	Miniature gauge (Logic Pressure), 0-4 barg
ETM-IS31-001	IS battery pack for electronic timer module
AGE-GE00-168	Electronic Timer Assembly c/w potted Timer Switch

Section 10: Glossary

Acronym	Definition
A&T	Alarm and Trip
AO	Alarm Only
CLAPS	Closed Loop Automatic Pressurization System
CU	Control Unit
ET	Electronic Timer
FCV	Flow Control Valve
IS	Intrinsically Safe
LC	Leakage Compensation
PA	Power and Alarm
RLV	Relief Valve Unit

Section 11: Drawings and Diagrams

Title	Drawing Number	Number of Sheets
D758 Control Unit - Electronic Timer	D758MOTORSYS-E	2
Motorpurge Hook-Up	MOTOR-HU	1
D758-3 P and I Diagram	D758-PI	1
D758 Circuit Diagram	AGM-PA00-021	1
D758 Ex e Terminal Box Layout	AGE-WC00154	1
Manual Override Switch Hook Up	AGE-WC00-117	1
Size 5 MOTORPURGE RLV	XBR-RTD0-009	1
MiniPurge® X LC Sequence Diagram	XBR-7TD0-040	1
System Status Indication	TP-518-058-WD	1

Section 12: Certifications

Certificates can be found in the accompanying booklet ML497.

Component	Certificate	Number
Purge System	EU Declaration of Conformity	SC004 *
	ATEX Certificate	SIRA 01ATEX1295X
	IECEX Certificate	IECEX SIR07.0027X
	INMETRO/TÜV Certificate	TÜV 12.1462X
	CCC Certificate	2020312304000830
	EAC Certificate	EA3C RU C-GB.AЖ58.B.00906/20
MIU/e Ex e Terminal Box	EU Declaration of Conformity	SC027 *
	ATEX Certificate	ExVeritas 19 ATEX0542X
	IECEX Certificate	IECEX EXV 19.0057X
	INMETRO/TÜV Certificate	TÜV 12.1463
	CCC Certificate	2020312303000422
Electronic Timer	EU Declaration of Conformity	SC039 *
	ATEX Certificate	FM 10 ATEX0003X
	IECEX Certificate	IECEX FME 10.0001X
Electronic Switches	ATEX Certificate	EPS 14 ATEX 1766 X
	IECEX Certificate	IECEX EPS 14.0092X
	CCC Certificate	2020322304000843
	EAC Certificate	EA3C RU C-DE.AH07.B.04162/22

* Documents are attached to the manual.

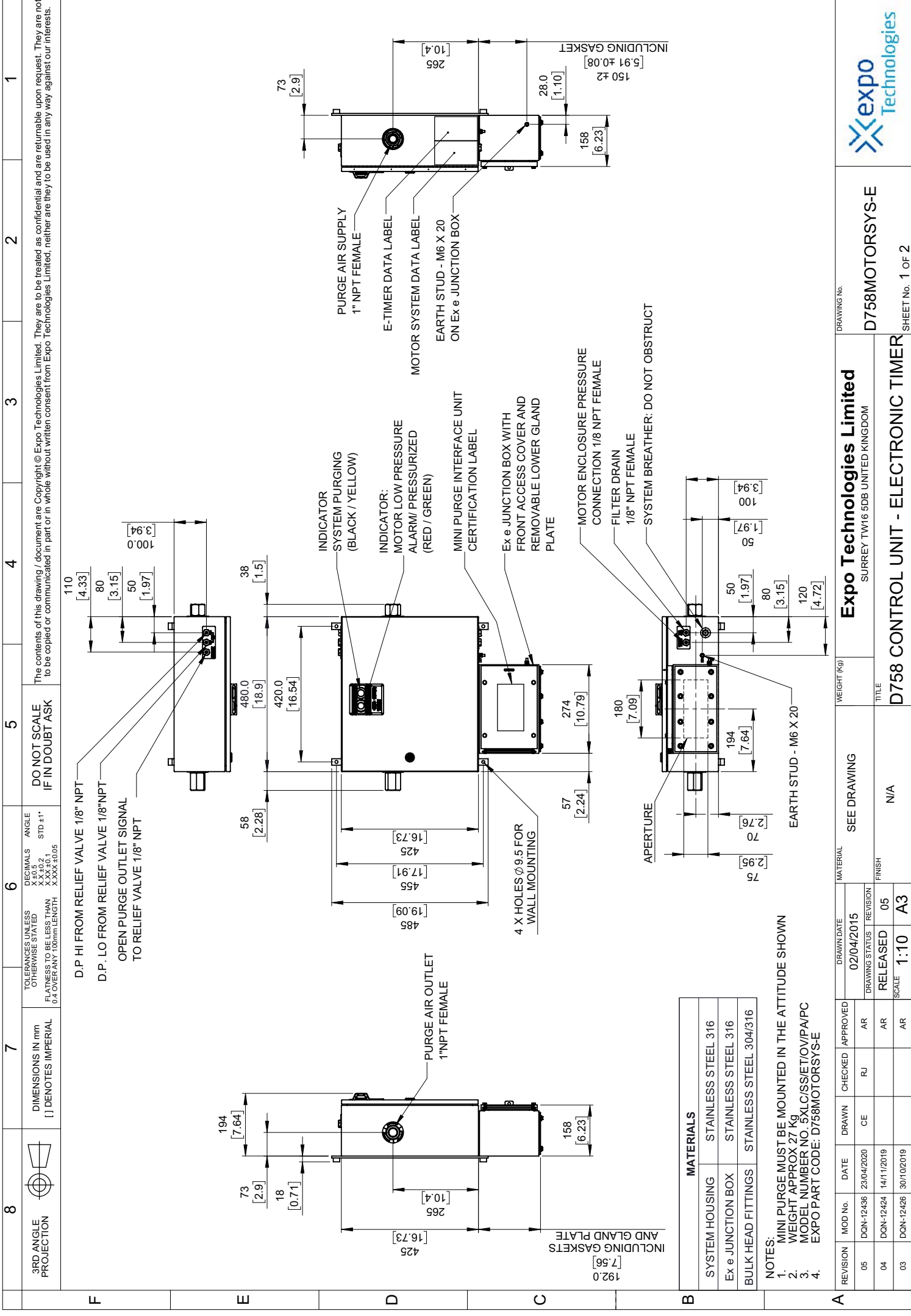

REV/VERSION	MOD No.	DATE	DRAWN	CHECKED	APPROVED	DRAWN/DATE	MATERIAL	SEE DRAWING	WEIGHT (Kg)	TITLE
05	DQIN-12436	23/04/2020	CE	RJ	AR	02/04/2015	STAINLESS STEEL 316	SEE DRAWING	27	D758 CONTROL UNIT - ELECTRONIC TIMER
04	DQIN-12424	14/11/2019			AR	RELEASED	STAINLESS STEEL 316			N/A
03	DQIN-12426	30/10/2019			AR	SCALE	STAINLESS STEEL 304/316			A3

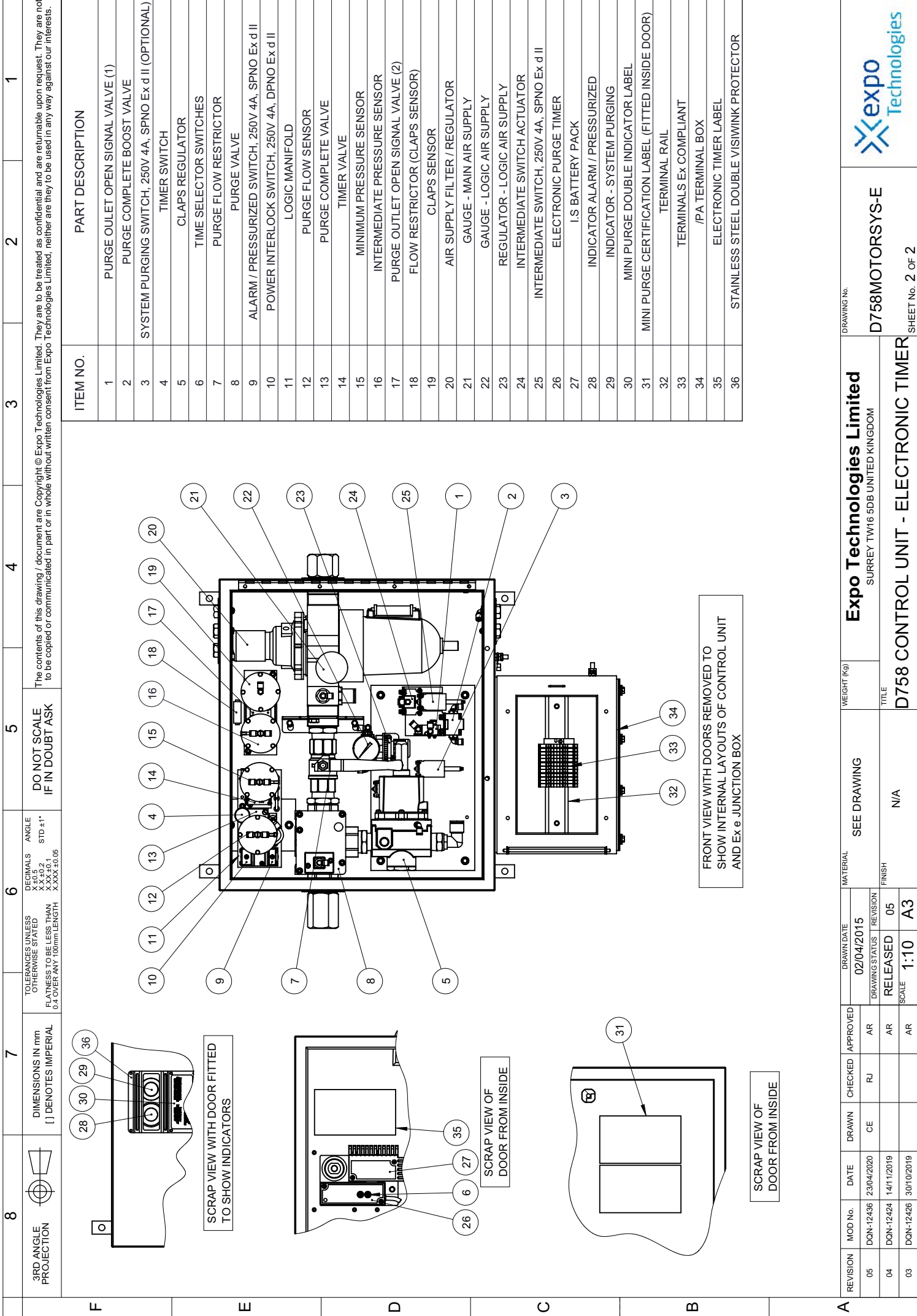

ITEM NO.	PART DESCRIPTION
1	PURGE OULET OPEN SIGNAL VALVE (1)
2	PURGE COMPLETE BOOST VALVE
3	SYSTEM PURGING SWITCH, 250V 4A, SPNO Ex d II (OPTIONAL)
4	TIMER SWITCH
5	CLAPS REGULATOR
6	TIME SELECTOR SWITCHES
7	PURGE FLOW RESTRICTOR
8	PURGE VALVE
9	ALARM / PRESSURIZED SWITCH, 250V 4A, SPNO Ex d II
10	POWER INTERLOCK SWITCH, 250V 4A, DPNO Ex d II
11	LOGIC MANIFOLD
12	PURGE FLOW SENSOR
13	PURGE COMPLETE VALVE
14	TIMER VALVE
15	MINIMUM PRESSURE SENSOR
16	INTERMEDIATE PRESSURE SENSOR
17	PURGE OULET OPEN SIGNAL VALVE (2)
18	FLOW RESTRICTOR (CLAPS SENSOR)
19	CLAPS SENSOR
20	AIR SUPPLY FILTER / REGULATOR
21	GAUGE - MAIN AIR SUPPLY
22	GAUGE - LOGIC AIR SUPPLY
23	REGULATOR - LOGIC AIR SUPPLY
24	INTERMEDIATE SWITCH ACTUATOR
25	INTERMEDIATE SWITCH, 250V 4A, SPNO Ex d II
26	ELECTRONIC PURGE TIMER
27	I.S BATTERY PACK
28	INDICATOR ALARM / PRESSURIZED
29	INDICATOR - SYSTEM PURGING
30	MINI PURGE DOUBLE INDICATOR LABEL
31	MINI PURGE CERTIFICATION LABEL (FITTED INSIDE DOOR)
32	TERMINAL RAIL
33	TERMINALS Ex COMPLIANT
34	/PA TERMINAL BOX
35	ELECTRONIC TIMER LABEL
36	STAINLESS STEEL DOUBLE VISIWINK PROTECTOR

3RD ANGLE PROJECTION

3

4

5

6

7

8

9

10

11

12

13

14

15

16

17

18

19

20

21

22

23

24

25

26

27

28

29

30

31

32

33

34

35

36

DO NOT SCALE IF IN DOUBT ASK

TOLERANCES UNLESS OTHERWISE STATED

DECIMALS X ±0.5

ANGLE STD ±1°

FLATNESS TO BE LESS THAN 0.4 OVER ANY 100mm LENGTH

DIMENSIONS IN mm [] DENOTES IMPERIAL

FRONT VIEW WITH DOORS REMOVED TO SHOW INTERNAL LAYOUTS OF CONTROL UNIT AND EX e JUNCTION BOX

SCRAP VIEW WITH DOOR FITTED TO SHOW INDICATORS

SCRAP VIEW OF DOOR FROM INSIDE

SCRAP VIEW OF DOOR FROM INSIDE

REVISION	MOD No.	DATE	DRAWN	CHECKED	APPROVED	DRAWING DATE	MATERIAL	WEIGHT (kg)	Expo Technologies Limited
05	DGN-12436	23/04/2020	CE	RJ	AR	02/04/2015	SEE DRAWING		SURREY TW16 5DB UNITED KINGDOM
04	DGN-12424	14/11/2019			AR	RELEASED	N/A		
03	DGN-12426	30/10/2019			AR	SCALE	1:10	A3	

DRAWING No. D758MOTORSYS-E

TITLE D758 CONTROL UNIT - ELECTRONIC TIMER

FINISH N/A

REVISION 05

SCALE 1:10

A3

SEE DRAWING

WEIGHT (kg)

Expo Technologies Limited

SURREY TW16 5DB UNITED KINGDOM

D758 CONTROL UNIT - ELECTRONIC TIMER

SHEET No. 2 OF 2

expo Technologies

8	7	6	5	4	3	2	1
3RD ANGLE PROJECTION 	DIMENSIONS IN mm [] DENOTES IMPERIAL	TOLERANCES UNLESS OTHERWISE STATED FLATNESS TO BE LESS THAN 0.4 OVER ANY 100mm LENGTH	DECIMALS X ±0.5 XX ±0.2 XXX ±0.1 X.XXX ±0.05	ANGLE STD ±1°	DO NOT SCALE IF IN DOUBT ASK	The contents of this drawing / document are Copyright © Expo Technologies Limited. They are to be treated as confidential and are returnable upon request. They are not to be copied or communicated in part or in whole without written consent from Expo Technologies Limited, neither are they to be used in any way against our interests.	

F
E
D
C
B
A

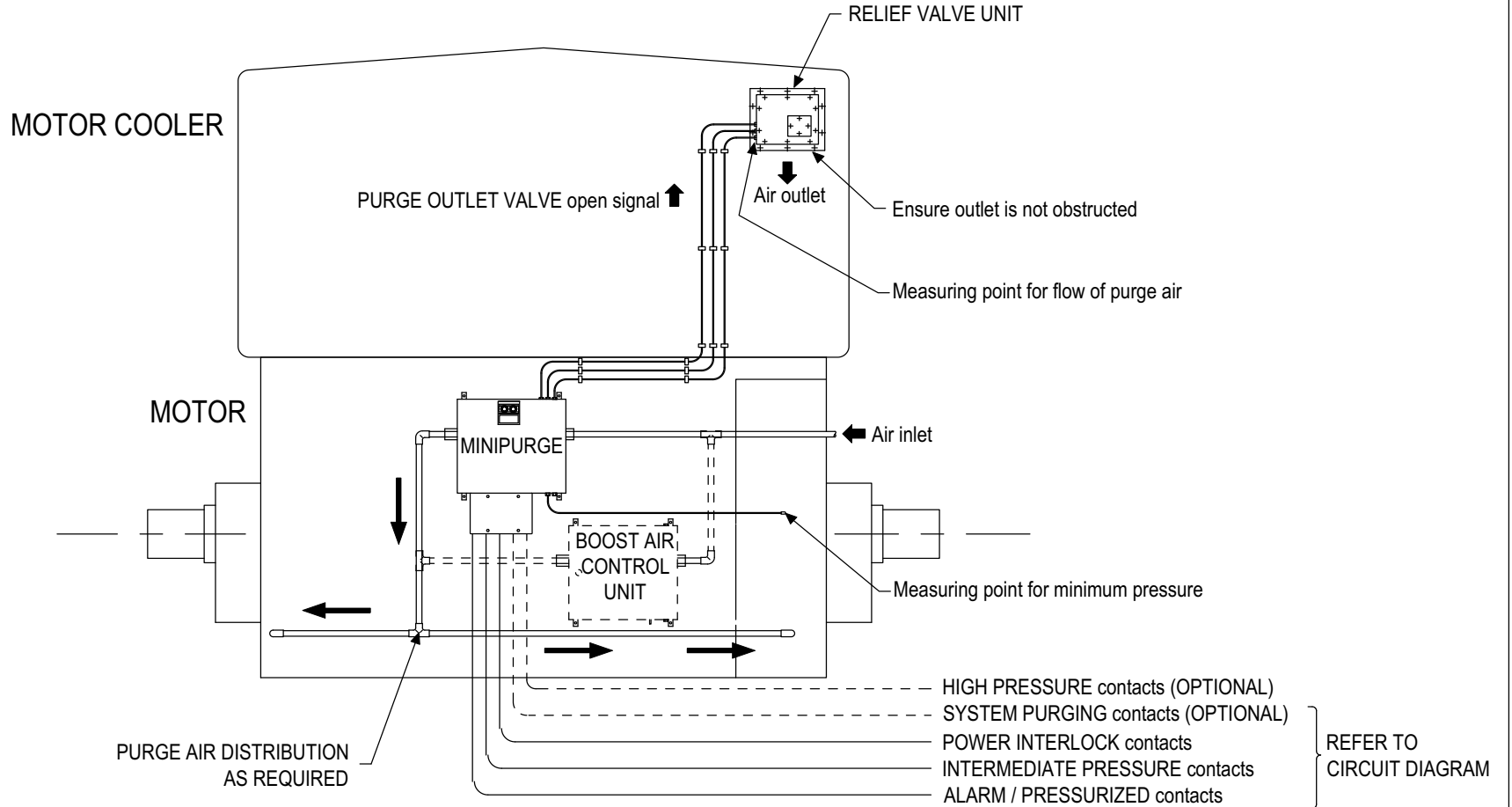

REVISION	MOD #	DATE	DRAWN	CHECKED	APPROVED	DRAWN DATE	MATERIAL	WEIGHT (Kg)	Expo Technologies Limited SURREY TW16 5DB UNITED KINGDOM	DRAWING No.	
03	03	27/04/20	CE	AR	MH	03/07/2019				MOTOR-HU	
02	02	19/02/20			MH	DRAWING STATUS	FINISH	TITLE		SHEET No. 1 OF 1	
01	01	03/07/19	LG	MLC	MLC	SCALE		MOTORPURGE HOOK UP			
						N.T.S	A3				

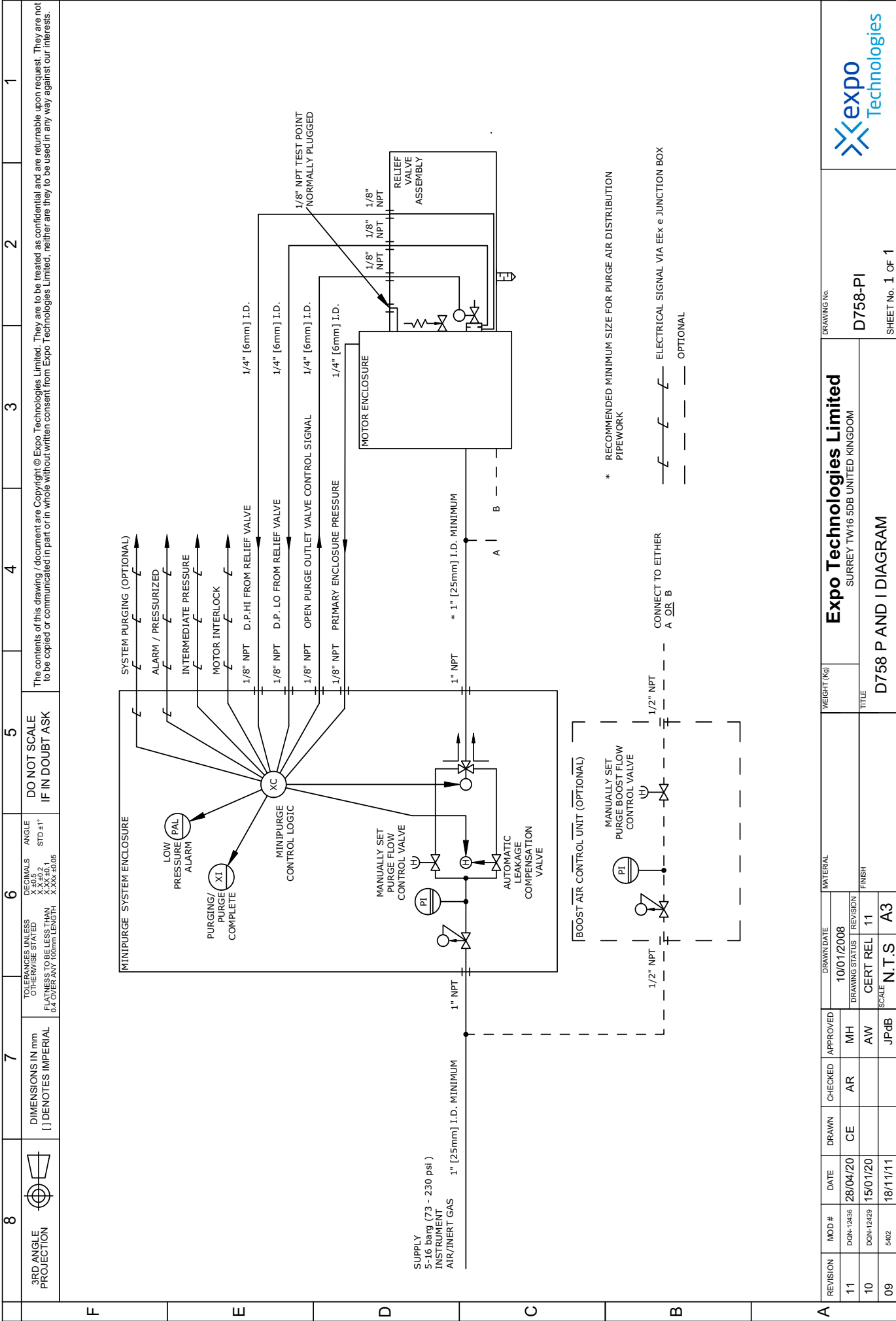

REVISION	MOD #	DATE	DRAWN	CHECKED	APPROVED	MATERIAL	WEIGHT (kg)	Expo Technologies Limited		DRAWING No.
11	DOH-12436	28/04/20	CE	AR	MH	10/01/2008		SURREY TW16 5DB UNITED KINGDOM		D758-PI
10	DOH-12429	15/01/20			AW	DRAWING STATUS: FINISH		D758 P AND I DIAGRAM		
09	5402	18/11/11			JPdB	DRAWING STATUS: N.T.S		D758 P AND I DIAGRAM		SHEET No. 1 OF 1



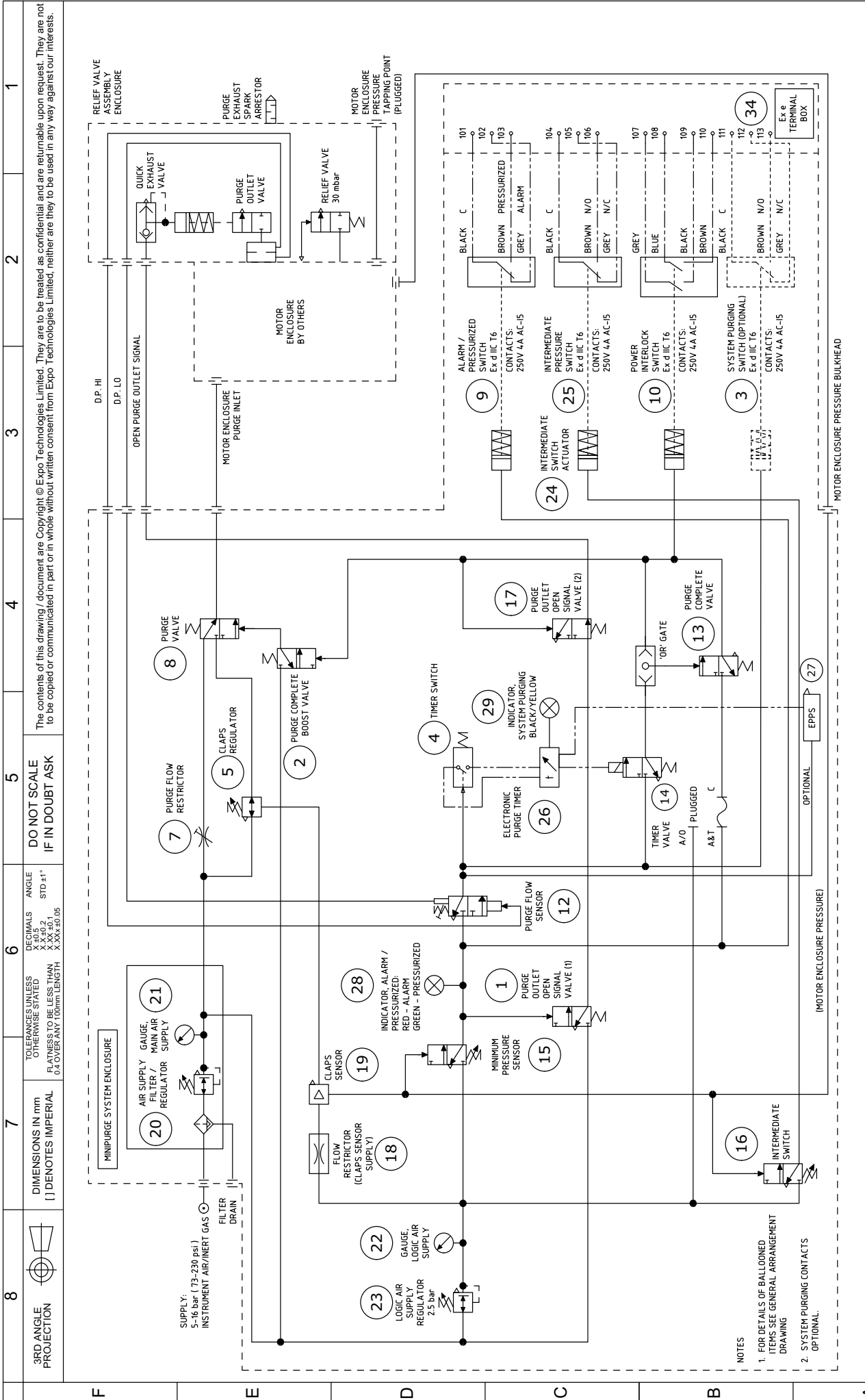



REVISION	MOD #	DATE	DRAWN	CHECKED	APPROVED	MATERIAL	WEIGHT (kg)
13	DON-12438	27/04/20	CE	AR	MH	23/10/2007	
12	6738	10/04/19			MLC	DRAWING STATUS / REVISION	
11	DON-12412	23/03/18			MLC	CERT REL 13	

Expo Technologies Limited		SURREY TW16 5DB UNITED KINGDOM	
DRAWING No. AGM-PA00-021		SHEET No. 1 OF 1	
D758 CIRCUIT DIAGRAM		TITLE	

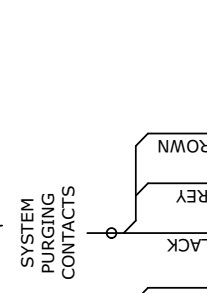

8	3RD ANGLE PROJECTION	7	DIMENSIONS IN mm [] DENOTES IMPERIAL	6	TOLERANCES UNLESS OTHERWISE STATED FLATNESS TO BE LESS THAN 0.4 OVER ANY 100mm LENGTH	5	DO NOT SCALE IF IN DOUBT ASK	4	3	2	1																																	
<p>The contents of this drawing / document are Copyright © Expo Technologies Limited. They are to be treated as confidential and are returnable upon request. They are not to be copied or communicated in part or in whole without written consent from Expo Technologies Limited, neither are they to be used in any way against our interests.</p>																																												
F	<p>SEE CIRCUIT DIAGRAM</p>																																											
E	 <p>ALARM/ PRESSURISED CONTACTS</p> <p>INTERMEDIATE PRESSURE CONTACTS</p> <p>POWER INTERLOCK CONTACTS</p> <p>101 102 103 104 105 106 107 108 109 110</p> <p>BLACK GREY BROWN BROWN GREY BLUE BLACK BROWN</p>																																											
D	<p>SEE CIRCUIT DIAGRAM</p>																																											
C	 <p>ALARM/ PRESSURISED CONTACTS</p> <p>INTERMEDIATE PRESSURE CONTACTS</p> <p>POWER INTERLOCK CONTACTS</p> <p>SYSTEM PURGING CONTACTS</p> <p>101 102 103 104 105 106 107 108 109 110 111 112 113</p> <p>BLACK GREY BROWN BROWN GREY BLUE BLACK BROWN BLACK GREY BROWN</p>																																											
B	<p>NOTES</p> <ol style="list-style-type: none"> EXTRA TERMINALS MAY BE FITTED. THE NUMBER OF TERMINALS MUST NOT EXCEED THE MAXIMUM SPECIFIED IN THE TERMINAL BOX CERTIFICATE - CONSULT EXPO TECHNOLOGIES. ALL TERMINALS MUST BE Ex e CERTIFIED DEMKO14ATEX1338U & IEC EXULD14.0005U DOUBLE LINES SHOW THE POSITION OF TERMINAL END PLATES MAXIMUM PER TERMINAL AT 55°C: 250V 4A (AC-15) 																																											
A	<p>TERMINAL LAYOUT FOR SYSTEM FITTED WITH "SYSTEM PURGING" CONTACTS</p>																																											
<table border="1"> <tr> <th>REVISION</th> <th>MOD #</th> <th>DATE</th> <th>DRAWN</th> <th>CHECKED</th> <th>APPROVED</th> <th>MATERIAL</th> <th>WEIGHT (Kg)</th> <th colspan="2">Expo Technologies Limited</th> <th>DRAWING No.</th> </tr> <tr> <td>09</td> <td>DOA-12436</td> <td>28/04/20</td> <td>CE</td> <td>AR</td> <td>MH</td> <td>02/11/2007</td> <td></td> <td colspan="2">SURREY TW16 5DB UNITED KINGDOM</td> <td>AGE-WC00-154</td> </tr> <tr> <td>08</td> <td>6728</td> <td>19/03/19</td> <td></td> <td></td> <td>MH</td> <td>CERT REL 09</td> <td></td> <td colspan="2">D758 Ex e TERMINAL BOX LAYOUT</td> <td>SHEET No. 1 OF 1</td> </tr> <tr> <td>07</td> <td>5402</td> <td>18/11/11</td> <td></td> <td></td> <td>JPdB</td> <td>SCALE N.T.S</td> <td></td> <td colspan="2">A3</td> <td></td> </tr> </table>	REVISION	MOD #	DATE	DRAWN	CHECKED	APPROVED	MATERIAL	WEIGHT (Kg)	Expo Technologies Limited		DRAWING No.	09	DOA-12436	28/04/20	CE	AR	MH	02/11/2007		SURREY TW16 5DB UNITED KINGDOM		AGE-WC00-154	08	6728	19/03/19			MH	CERT REL 09		D758 Ex e TERMINAL BOX LAYOUT		SHEET No. 1 OF 1	07	5402	18/11/11			JPdB	SCALE N.T.S		A3		
REVISION	MOD #	DATE	DRAWN	CHECKED	APPROVED	MATERIAL	WEIGHT (Kg)	Expo Technologies Limited		DRAWING No.																																		
09	DOA-12436	28/04/20	CE	AR	MH	02/11/2007		SURREY TW16 5DB UNITED KINGDOM		AGE-WC00-154																																		
08	6728	19/03/19			MH	CERT REL 09		D758 Ex e TERMINAL BOX LAYOUT		SHEET No. 1 OF 1																																		
07	5402	18/11/11			JPdB	SCALE N.T.S		A3																																				

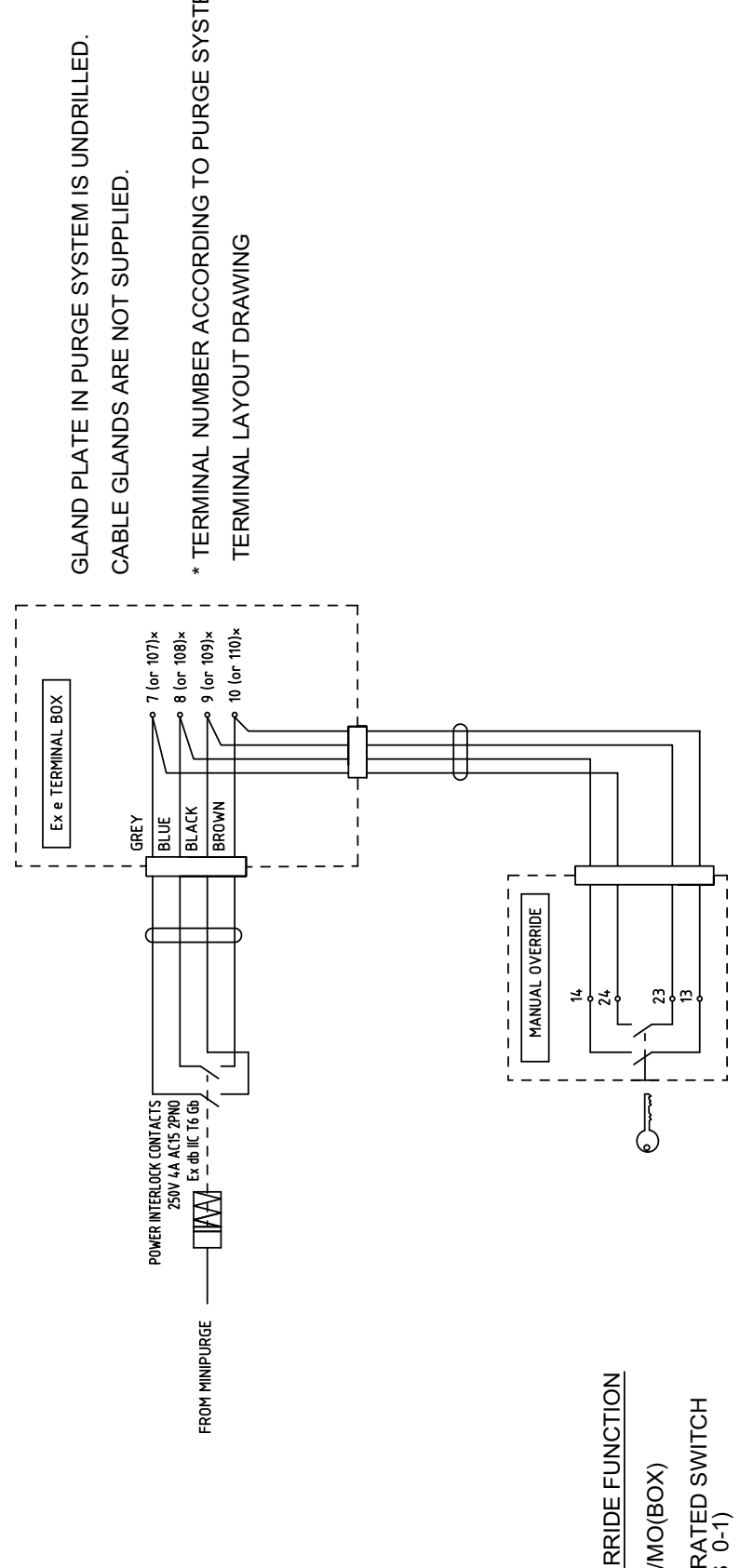

	8	3RD ANGLE PROJECTION	7	DIMENSIONS IN mm (1) DENOTES IMPERIAL	6	TOLERANCES UNLESS OTHERWISE STATED FLATNESS TO BE LESS THAN 0.4 OVER ANY 100mm LENGTH	6	DECIMALS ANGLE X.XX ±0.5 STD ±1° X.XX ±0.1 X.XX ±0.05	5	DO NOT SCALE IF IN DOUBT ASK	4	3	2	1																																								
F	<p>The contents of this drawing / document are Copyright © Expo Technologies Limited. They are to be treated as confidential and are returnable upon request. They are not to be copied or communicated in part or in whole without written consent from Expo Technologies Limited, neither are they to be used in any way against our interests.</p>  <p>GLAND PLATE IN PURGE SYSTEM IS UNDRILLED. CABLE GLANDS ARE NOT SUPPLIED.</p> <p>* TERMINAL NUMBER ACCORDING TO PURGE SYSTEM TERMINAL LAYOUT DRAWING</p>																																																					
E	<p>MANUAL OVERRIDE FUNCTION</p> <p>PART CODE /MO(BOX)</p> <p>VIA KEY-OPERATED SWITCH (2 POSITIONS 0-1)</p> <p>GRP ENCLOSURE, IP66 1 X M20 ENTRY</p> <p>SWITCH RATING 550VAC/10A (AC-15) 110VDC / 2.5A (DC-13)</p> <p>TEMP RATING -60 TO +55°C</p> <p>ATEX / IECEx / EAC / BRAZIL / CSA / PESO / cULus Ex db eB IIC T5 Gb Ex tb IIIC T95°C Db</p>																																																					
D																																																						
C																																																						
B																																																						
A	<table border="1"> <thead> <tr> <th>REVISION</th> <th>MOD #</th> <th>DATE</th> <th>DRAWN</th> <th>CHECKED</th> <th>APPROVED</th> <th>DRAWN DATE</th> <th>MATERIAL</th> </tr> </thead> <tbody> <tr> <td>13</td> <td>DDN-12472</td> <td>01/04/21</td> <td>AR</td> <td>CE</td> <td>AW</td> <td>01/07/2013</td> <td></td> </tr> <tr> <td>12</td> <td>DDN-12446</td> <td>20/07/20</td> <td>AR</td> <td>CE</td> <td>AW</td> <td>CERT REL 13</td> <td>FINISH</td> </tr> <tr> <td>11</td> <td>DDN-12429</td> <td>05/05/20</td> <td>AR</td> <td>CE</td> <td>MH</td> <td>N.T.S</td> <td>A3</td> </tr> </tbody> </table>	REVISION	MOD #	DATE	DRAWN	CHECKED	APPROVED	DRAWN DATE	MATERIAL	13	DDN-12472	01/04/21	AR	CE	AW	01/07/2013		12	DDN-12446	20/07/20	AR	CE	AW	CERT REL 13	FINISH	11	DDN-12429	05/05/20	AR	CE	MH	N.T.S	A3	<table border="1"> <thead> <tr> <th>WEIGHT (KG)</th> <th>TITLE</th> </tr> </thead> <tbody> <tr> <td></td> <td>MANUAL OVERRIDE SWITCH HOOK-UP</td> </tr> </tbody> </table>	WEIGHT (KG)	TITLE		MANUAL OVERRIDE SWITCH HOOK-UP	<table border="1"> <thead> <tr> <th colspan="2">Expo Technologies Limited</th> </tr> </thead> <tbody> <tr> <td colspan="2">SURREY TW16 5DB UNITED KINGDOM</td> </tr> </tbody> </table>	Expo Technologies Limited		SURREY TW16 5DB UNITED KINGDOM		<table border="1"> <thead> <tr> <th colspan="2">DRAWING No.</th> </tr> </thead> <tbody> <tr> <td colspan="2">AGE-WC00-117</td> </tr> </tbody> </table>	DRAWING No.		AGE-WC00-117		<table border="1"> <thead> <tr> <th colspan="2">SHEET No.</th> </tr> </thead> <tbody> <tr> <td colspan="2">1 of 1</td> </tr> </tbody> </table>	SHEET No.		1 of 1		
REVISION	MOD #	DATE	DRAWN	CHECKED	APPROVED	DRAWN DATE	MATERIAL																																															
13	DDN-12472	01/04/21	AR	CE	AW	01/07/2013																																																
12	DDN-12446	20/07/20	AR	CE	AW	CERT REL 13	FINISH																																															
11	DDN-12429	05/05/20	AR	CE	MH	N.T.S	A3																																															
WEIGHT (KG)	TITLE																																																					
	MANUAL OVERRIDE SWITCH HOOK-UP																																																					
Expo Technologies Limited																																																						
SURREY TW16 5DB UNITED KINGDOM																																																						
DRAWING No.																																																						
AGE-WC00-117																																																						
SHEET No.																																																						
1 of 1																																																						

8	7	6	5	4	3	2	1
3RD ANGLE PROJECTION	DIMENSIONS IN mm [] DENOTES IMPERIAL	TOLERANCES UNLESS OTHERWISE STATED FLATNESS TO BE LESS THAN 0.4 OVER ENTIRE LENGTH	DO NOT SCALE IF IN DOUBT ASK				
		DECIMALS XXX.0.2 XXX.0.1 XXX.0.05					
		ANGLE STD ±1°					

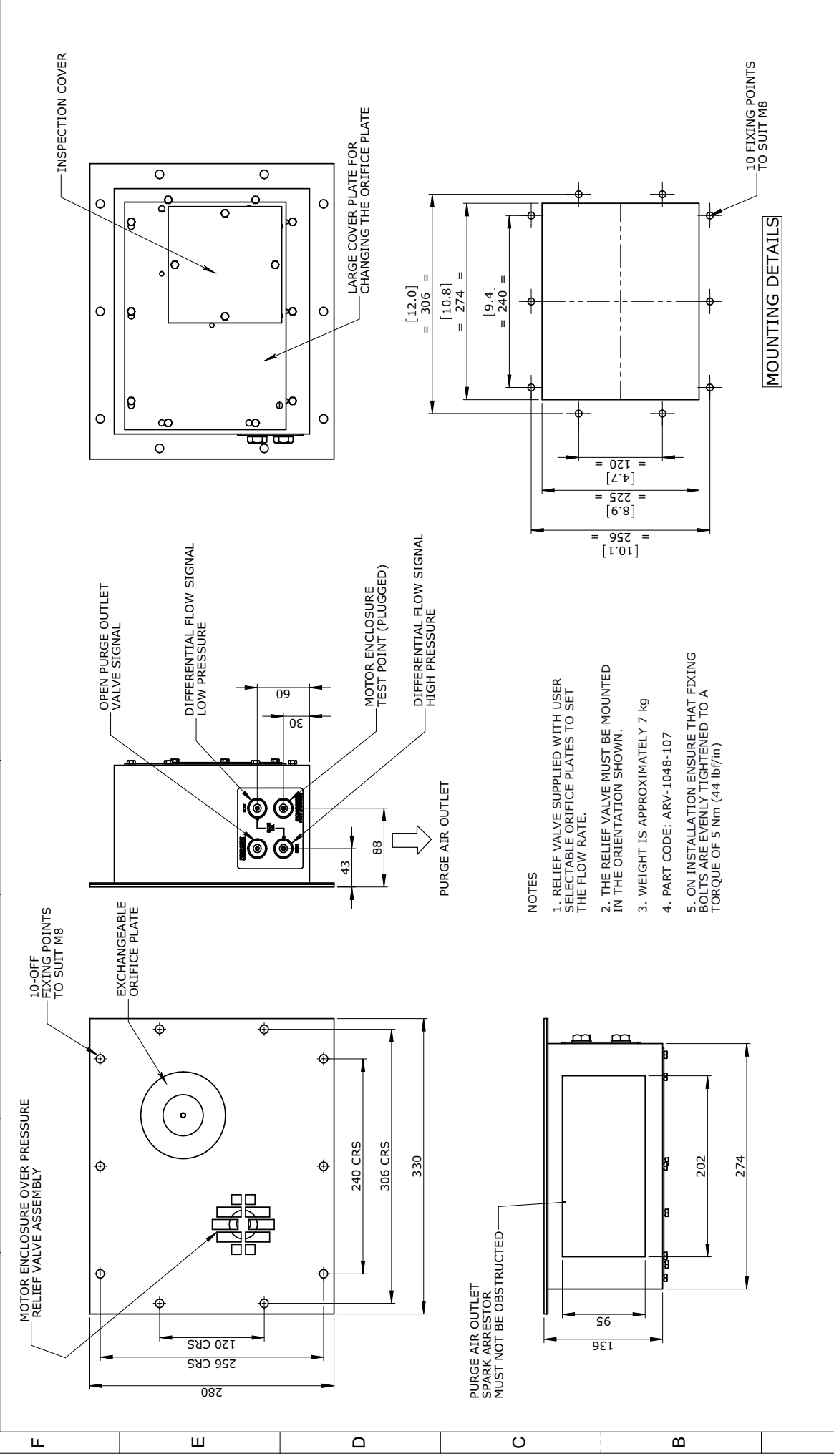

NOTES

1. RELIEF VALVE SUPPLIED WITH USER SELECTABLE ORIFICE PLATES TO SET THE FLOW RATE.
2. THE RELIEF VALVE MUST BE MOUNTED IN THE ORIENTATION SHOWN.
3. WEIGHT IS APPROXIMATELY 7 kg
4. PART CODE: ARV-1048-107
5. ON INSTALLATION ENSURE THAT FIXING BOLTS ARE EVENLY TIGHTENED TO A TORQUE OF 5 Nm (44 lb/ft/in)

REVISION	MOD No.	DATE	DRAWN	CHECKED	APPROVED	DRAWN DATE	MATERIAL	WEIGHT (kg)	Expo Technologies Limited SURREY TW16 5DB UNITED KINGDOM	DRAWING No.
04	DON-12436	27/04/2020	CE	AR	MH	11/02/2009	STAINLESS STEEL 316L 1.5mm THK		XBR-RTD0-009	
03	4793	16/10/2009			JP-DB	CERTIFIED	FINISH			
02	4666	17/04/2009			JP-DB	SCALE	VAPOUR BLAST			
							1:5	A3	SIZE 5 MOTORPURGE RLV	SHEET No. 1 of 1



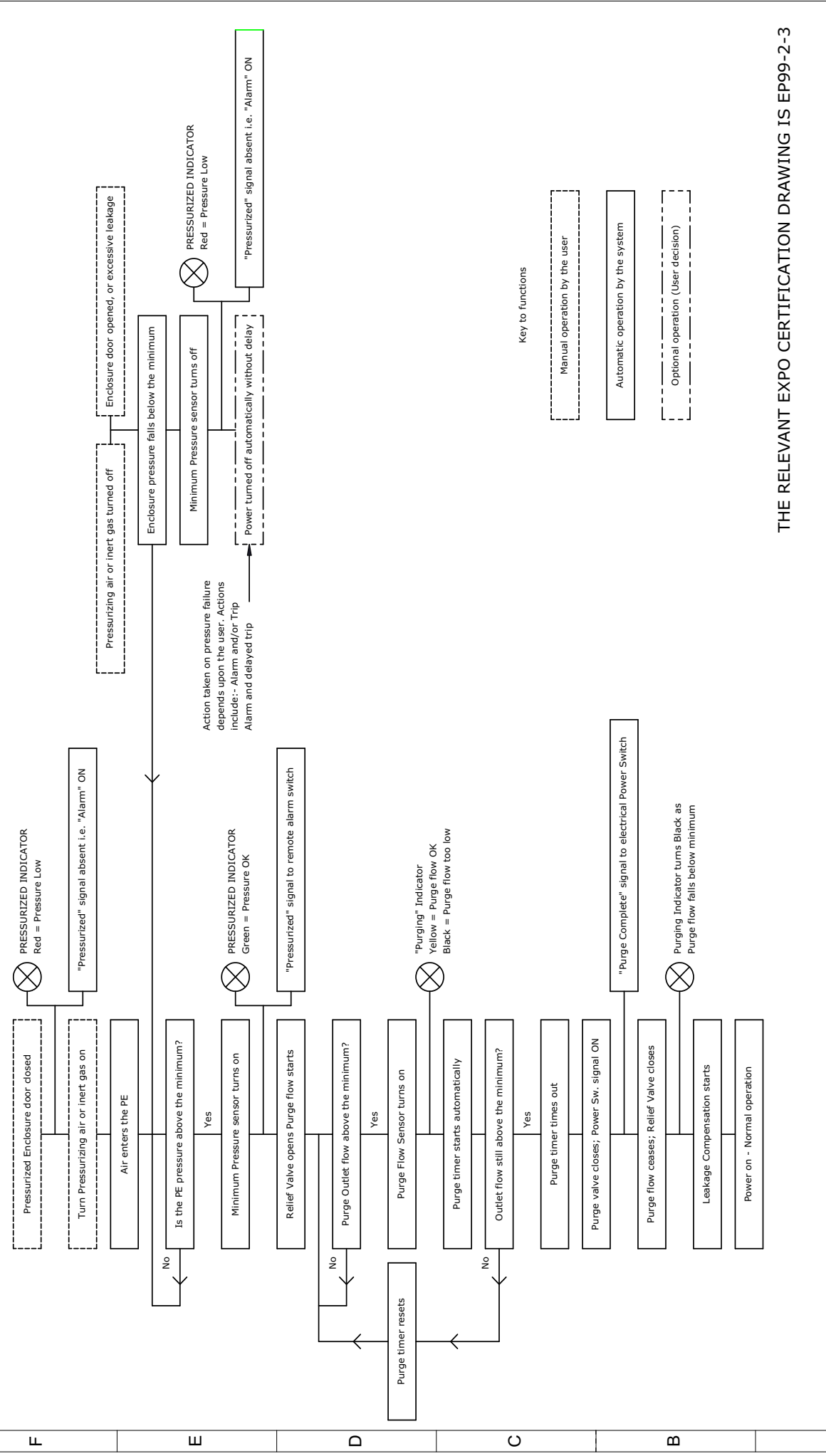









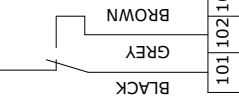
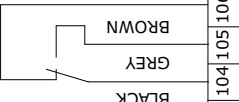
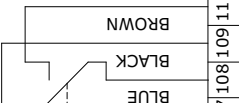
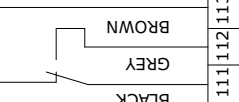

REVISION	MOD No.	DATE	DRAWN	CHECKED	APPROVED	DRAWN DATE	MATERIAL	WEIGHT (Kg)
03	DOH-12436	28/04/2020	AW	AR	MH	23/06/2010		
02	5434	20/12/2011			JPB	CERTIFIED	03	
01	DRAWN	23/06/2010			JPB	SCALE	1:1	A3

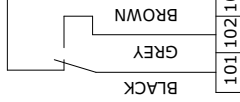
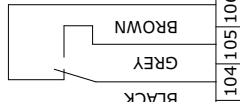
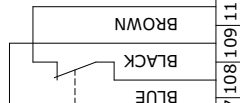
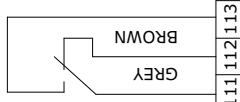
Expo Technologies Limited		SURREY TW16 5DB UNITED KINGDOM	
DRAWING No. XBR-7TD0-040		TITLE MINIPURGE X LC SEQUENCE DIAGRAM	
SHEET No. 1 OF 1			

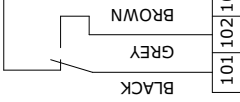
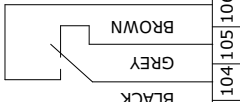
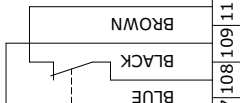
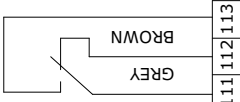
THE RELEVANT EXPO CERTIFICATION DRAWING IS EP99-2-3

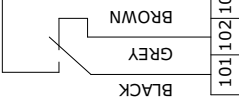

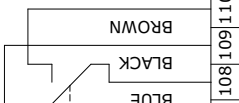
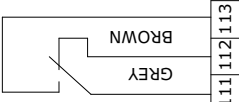
SYSTEM STATUS	INDICATORS	101 102 103	104 105 106	107 108 109 110	111 112 113
DURING PURGE	 GREEN  YELLOW				
PURGE COMPLETE - NORMAL OPERATION	 GREEN  BLACK				
INTERMEDIATE OR PRE-ALARM	 GREEN  BLACK				
MOTOR LOW PRESSURE SHUTDOWN	 RED  BLACK				

A	REVISION	MOD No.	DATE	DRAWN	CHECKED	APPROVED	DRAWN DATE	MATERIAL	WEIGHT (kg)	Expo Technologies Limited SURREY TW16 5DB UNITED KINGDOM TP-518-058-WD SYSTEM STATUS INDICATION SHEET No. 2 OF 2
	07	DON-12438	27/04/2020	CE	AR	MH	13/09/2009			
	06	6588	14/07/2017			JP/GB	CERTIFIED	07		
	05	5682	01/11/2012			NW	SCALE	1:1	A3	



MiniPurge Interface Unit MIU/e User Instruction Manual

Manufacturer: **Expo Technologies Ltd**, Unit 2 The Summit, Sunbury on Thames. UK.

Model Type & Rating:

MIU/e1	MIU/e2	MIU/e1/MO
400V / 7A	400V / 7A	400 V / 2A

Certificates:

Hazardous Area Marking Code:

IECEX EXV 19.0057X	ExVeritas 19 ATEX 0542X	TUV 12.1463
Ex eb IIC T5 Gb Ex tb IIIC T100°C Db Tamb -20°C to +55°C	⊕ II 2 G Ex eb IIC T5 Gb ⊕ II 2 D Ex tb IIIC T100°C Db Tamb -20°C to +55°C	Ex e IIC T5 Gb Ex tb IIIC T100° Db IP66 Tamb -20°C to +55°C
Ex eb IIC T4 Gb Tamb -20°C to +60°C	⊕ II 2 G Ex eb IIC T4 Gb Tamb -20°C to +60°C	Ex e IIC T4 Gb Tamb -20°C to +60°C

APPLICATION SUITABILITY

The MiniPurge Interface Units – MIU/e are certified for use in Hazardous Areas – where the Hazardous Area is non-mining (i.e. above ground) and the hazard is caused by flammable gasses or vapours.

The systems may be used in ATEX/IECEX Gas Zones 1 & 2, Gas Groups IIA, IIB & IIC and in Dust Zones 21 & 22, Dust Groups IIIA, IIIB & IIIC.

The following materials are used in the construction of MIU/e: Stainless Steel, Steel, Brass, Copper, Polyamide, Silicone. If substances that will adversely affect any of these materials are present in the surrounding environment, please consult Expo Technologies for further guidance. This equipment is designed for use under normal industrial conditions of ambient temperature, humidity and vibration. Please consult Expo Technologies before installing this equipment in conditions that may cause stresses beyond normal industrial conditions.

WARNING - Only install, commission, inspect, maintain or fault find when safe to do so.

INSTALLATION

The MIU/e shall be installed in accordance with relevant standards, such as IEC 60079-14 and any local codes of practice that are in force.

The MIU/e shall be connected to the Purge and Pressurization system in accordance with the instructions given in the handbook supplied with the pressurization system.

The external earth connection of the MIU/e shall be connected to earth using minimum 4mm² conductor.

SELECTION OF CABLE, CABLE GLANDS AND CONDUCTORS IN CONDUIT

Cable glands or other cable entry devices shall be appropriately certified and suitable for the cable and the conditions of use and be installed in accordance with the manufacturer's instructions.

When the MIU/e application requires the hazardous area marking code:

Ex eb IIC T5 Gb, Tamb -20°C to +55°C there is no further guidance for the selection of cable and cable glands or conductors in conduit.

When the MIU/e application requires the hazardous area marking code:

Ex eb IIC T4 Gb, Tamb -20°C to +60°C the user shall select cable and cable glands or conductors in conduit that have a higher temperature rating than 83.2°C.

TERMINALS

MIU/e may be fitted with a combination of:

WDU2.5 terminals certified to DEMKO 14 ATEX 1338U & IECEX ULD 14.0005U.

SAK2.5 terminals certified to KEMA 97 ATEX 1798U & IECEX KEM06.0014U.

WPE2.5 Earth terminals certified to DEMKO 14 ATEX 1338U & IECEX ULD 14.0005U.

For all type of terminals: Tightening torque range: 0.4 to 0.8 Nm (WDU & WPE) & 0.4 to 0.6 Nm (SAK).

Conductor cross section maximum 2.5 mm², minimum 1.5 mm².

Type of connection is screwed - Solid copper conductors to be used.

Stripping length shall be 10 mm.

Only one conductor is allowed at each side of a terminal. Multiple conductors shall be crimped together before screwed into the terminal.

Maximum number of terminals: For Model MIU/e1 – Up to 18 current carrying terminals.

For Model MIU/e2 – Up to 33 current carrying terminals.

For Model MIU/e1/MO – Up to 13 current carrying terminals.

COMMISSIONING

The installation of the cable glands, electrical and earth connections shall be inspected for correct installation before the unit is put into service. The lid shall be correctly fitted.

MAINTENANCE

The condition of enclosure and associated cable glands shall be inspected for damage every six months. The terminals shall be inspected for tightness and gaskets inspected for damage.

FAULT FINDING

When wiring or signal fault occurs, check each terminated wire, terminals for tightness and gaskets for damage.

External faults such as broken switches within the Control Unit may also require investigation.

EU Declaration of Conformity



This declaration of conformity is issued under the sole responsibility of the manufacturer and EU authorised representative named above:

Object of the declaration:

Product Name:	MiniPurge Controller System
Product Options:	This declaration covers all variants associated with the above product

The object of the declaration described above is in conformity with the relevant Union harmonization legislation:

Type of Legislation:
Electromagnetic Compatibility Directive (EMC) 2014/35/EU
ATEX Directive 2014/34/EU

The Following harmonised standards and technical specifications have been applied:

Type of Legislation:	General Standard:	Reference Standard:
EMC Directive:	Generic standards - immunity for industrial environments	EN 61000-6-2:2005
	Generic standards - Emission standard for industrial environments	BS EN IEC 61000-6-4:2007
ATEX Directive:	Equipment general requirements 0:2018/AC:2020	EN IEC 60079-0:2018/AC:2020
	Equipment protection by intrinsic safety "i"	EN 60079-11:2012
	Equipment protection by pressurized enclosure "p"	EN 60079-2:2014

Notified Body:

NB Name:	ExVeritas
NB Number:	2804

Technical documentation and assessments are in the Expo Technologies confidential technical file SC004.

For and on behalf of Expo Technologies Ltd



John Paul De Beer
Managing Director

Date: 17th October 2024

EU Declaration of Conformity



This declaration of conformity is issued under the sole responsibility of the manufacturer and EU authorised representative named above:

Object of the declaration:

Product Name:	MiniPurge Interface Units (MIU/e)
Product Options:	This declaration covers all variants associated with the above product

The object of the declaration described above is in conformity with the relevant Union harmonization legislation:

Type of Legislation:
ATEX Directive 2014/34/EU

The following harmonised standards and technical specifications have been applied:

Type of Legislation:	General Standard:	Reference Standard:
ATEX Directive:	Equipment general requirements	EN IEC 60079-0:2018
	Equipment protection by increased safety "e"	EN 60079-7:2015+A1:2018
	Equipment dust ignition protection by enclosure "t"	EN 60079-31:2014

Notified Body:

NB Name:	ExVeritas
NB Number:	2804

Technical documentation and assessments are in the Expo Technologies confidential technical file SC027.

For and on behalf of Expo Technologies Ltd



John Paul De Beer
Managing Director

Date: 7th May 2024

EU Declaration of Conformity



This declaration of conformity is issued under the sole responsibility of the manufacturer and EU authorised representative named above:

Object of the declaration:

Product Name:	Electronic Timer Module (ETM-IS**_***)
Product Options:	This declaration covers all variants associated with the above product

The object of the declaration described above is in conformity with the relevant Union harmonization legislation:

Type of Legislation:
ATEX Directive 2014/34/EU

The following harmonised standards and technical specifications have been applied:

Type of Legislation:	General Standard:	Reference Standard:
ATEX Directive:	Equipment general requirements	EN IEC 60079-0: 2018
	Equipment protection by intrinsic safety "i"	EN 60079-11: 2012

Notified Body:

NB Name:	ExVeritas
NB Number:	2804

Technical documentation and assessments are in the Expo Technologies confidential technical file SC039.

For and on behalf of Expo Technologies Ltd



John Paul De Beer
Managing Director

Date: 7th May 2024

Expo Technologies Ltd.

Expo Technologies Ltd.
Unit 2 The Summit, Hanworth Road
Sunbury-on-Thames,
TW16 5DB, UK
T : +44 20 8398 8011
E : sales@expoworldwide.com

EU-Authorised Representative

Expo Pharma Engineering
Unit 46, Eastgate Drive
Little Island, Co. Cork
T45 WR6, Ireland
E : euar@expopharma.ie

Expo Technologies Inc.

Expo Technologies Inc.
9140 Ravenna Road Unit #3
Twinsburg,
OH 44087, USA
T: +1 440 247 5314
E: sales.na@expoworldwide.com

Expo Technologies China

Qingdao Expo M&E Technologies Co. Ltd
617 Shilin Er Lu
Jimo District, Qingdao,
266200, China
T: +86 532 8906 9858
E: qingdao@expoworldwide.com

www.expoworldwide.com